

DEVELOPMENT AND EVALUATION OF A LOCAL INDUSTRIAL MACHINE FOR WATERMELON SEEDS EXTRACTION

Shreen, F.A. Mohamed.

Researcher, of Agr. Eng. Res. Inst. (AEnRI), Dokki; Giza, Egypt.

ABSTRACT

The overall objective of the present investigation was to modify and evaluate the performance of a local manufactured machine for extracting seeds from watermelon seeds. There were two problems facing the traditional machine, firstly, the seeds which extricated by the machine must be washed and the second problem was the increase of seeds damage ratio. To overcome these problems washing unit was added in the end of separating stage. The primary experiments show that the principle part which caused the increase in seed damage was crush drum. Then; theoretical studies were carried out to determine the permissible feed rate, knives number on crash drum, drum speed and clearance between crash drum and concave. The results indicated that the maximum value of cleaning efficiency was 93.8% with concave clearance of 3 cm, drum speed of 0.46 m/sec, knives number of 14 and feed rate of 60 kg/min. Too, the minimum value of 79.0% was obtained under concave clearance of 1 cm, drum speed of 1.4m/s, knives number of 6 and feed rate of 120kg/min. The Maximum cost value of 1052 LE/ton was achieved at feeding rate of 60 kg/min and drum speed of 1.4m/s. While, the least cost was estimated at 120 kg/min feed rate for all different ranges of drum speed. The developed unit saved about 61.4 % and the cost per ton was 1052LE compared to the manual extraction.

INTRODUCTION

Seed melon (*Colocynthis citrullus*), belongs to the Cucurbitaceae family, it is a strategic vegetable products in Egypt that can be exported to several Arab countries and cultivated in the arid and semi-arid areas of northern half of the Nile Delta in Egypt, and newly cultivated in reclaimed land. Vergano *et al.* (1992) studied the design aspects and performance of an axial-flow vegetable seed extracting machine. They compared the manual with the mechanical seed extraction for different vegetable fruits. They found that the manual seed extraction output was 0.47, 1.20, 1.26, 1.56, 1.83, 2.20 and 3.14 kg/man-h for cucumber, watermelon, tomato, summer squash, brinjal, squash melon and chilies, respectively. While, the productivity of the seed extracting machine varied from 310 to 1930 kg/h for all investigated vegetable fruits. They added that germination count for mechanically extracted seeds was higher than for the manually extracted seeds. Humeida and Hobani (1993) reported that the methods of extracting vegetable seeds from soft fruits include the following steps: 1) Cutting and smashing the fruits mechanically as in tomatoes and watermelons or cutting them into two-halves manually using a knife as in sweet melon. 2) Extracting seeds from surrounding gelatin and smashed fruit parts by leaving the mixture from 2 to 4 days to ferment as in tomatoes or proceeding extraction mechanically as in different cucurbitaceous, pepper, eggplant and tomato. 3) Washing seed using running water. 4) Drying seeds naturally in drying climate or by

exposing them to current of warm air in humid climate. George, (1985) stated that the watermelon seeds are extracted by cutting up fruits manually or mechanically then separated the seeds should be separated from pulp by washing with water manually or mechanically, then seeds are dried and cleaned. Akubuo and Odigboh (1999) found that the production rate of manual extracting machine prototype was about 458 fruits/h while the motorized machine was 2390 fruits/h as against a hand-peeling rate of 29 fruits/h. The decomposition of the mesocarp and endocarp was accelerated by coring the seed-bearing pulp of the fruits took 2 days to decompose as against 7 days for the traditional method. Matouk et al. (1999) evaluated the effect of some mechanical parameters on handling characteristics of sphere-like crops. They showed that the best ever handling result was obtained at 0.2 m/s speed of fruit feeding chain, 200 rpm sieve rocking speed and 15 degree of sieve slope angle during fruits handling using rectangular cell shape. Abou El-Magd et al. (2002) stated that saving several million of pounds in Egyptian economy requires developing of locally and reliable machinery such as seed extraction equipment to suit in the prevailing Egyptian conditions. Abdel- Mageed et al. (2006) designed and evaluated equipment for extraction watermelon seeds. They found that the proper performance of the fabricated equipment has been achieved at crushing drum speed of 4.7 m/s, clearance concave of 24 mm and cleaning brushes number of 8 that rotating at peripheral speed of 4.7 m/s. Whereas, at these operating conditions maximum equipment productivity values of 217.4 kg/h, cleaning efficiency of 84.7%, minimum visible seed damage values of 0.398%, and minimum seed losses values of 3.83% have been recorded. The average unit power required for accomplishing all processes of the fabricated equipment may be amounted as 10.75 kW. While, the average net profit due to replacing the fabricated equipment instead of the manual extraction method of watermelon seeds may be amounted as 2992 L.E/fed. Abu Shieshaa et al (2006) evaluated the effect of moisture content on some physical and mechanical properties of seed melon seeds and their kernel. The average length, width, thickness, mass and hardness of 100 seeds were 12.42, 7.80, 2.37 mm, 0.097g and 64.8 N, respectively, at a seed moisture content of 9.53% (w.b.) corresponding values of kernel, were 10.5, 6.50, 1.64mm, 0.061g and 14.0 N. The increase of seed moisture content from 9.53 to 24.08% leads to increase the bulk density of seed and kernel from 490 to 600 and 510 to 640 kg/m³, respectively. However, the true density of seed was decreased from 1160 to 1000kg/m³. Meanwhile, it increased from 1015 to 1150 kg/m³ for kernel. The porosity decreased from 58 to 41 and 50 to 40% for seed and kernel, respectively. The highest values of terminal velocity were 6.4, 4.67 and 3.94 for seed, kernel and hull, respectively, at seed moisture content of 24.08%. In the same manner the same increase in seed moisture content increased the static coefficient of friction of seed from 0, 24 to 0.65, 0.23 to 0.80 and 0.34 to 0.90 for galvanize metal, stainless steel and plywood, respectively. While, the corresponding values of static coefficient of friction of kernels were 0.23 to 0.68, 0.27 to 0.75 and 0.33 to 0.80 for the same mentioned above surfaces. The angle of repose increased

from (27 to 43 deg) for seeds and (31 to 41) deg for kernels with an increase in moisture content from 9.53 to 24.08 (w.b.).

The objectives of the present study were to treat some negative effects from using a local industrial machine by adding washing unit to this machine as well as decrease the seeds damage, from theoretical study to determine the limited range of feed rate and clearance between drum and concave which suitable opening feed of machine then; determine the limited range of crashing drum clearance under different available drum speeds. Finally evaluate these values under the used extract machine.

MATERIALS AND METHODS

The overall objective of the present investigation was to develop and evaluate the performance of a local extraction machine of watermelon seeds. It has three main construction advantages; the advantages of such construction are that: Firstly it can moved from any place in the field, so it decreased employer's number, efforts, time, and money comparing with stationary machines and manual method, secondly, the increase of the capacity volume of this machine. Thirdly, the industrial facility of this machine which helps a local workshop to produce it's so; it can be used in many large places in Egyptian field. But there were two problems that faced this machine. Firstly; the extracted seeds from this machine needed to manual washing process and the second problem were the increase of seeds damaged ratio. To overcome these problems washing unit was added to the machine in the end of separate stage. To solve the second problem, the permissible feed rate, knives number on crashing drum and clearance between crashing drum and concave were determined from theoretical studies.

The developed machine had three sections. The front part was the crushing portion; it consists of crushing drum and cut knives in the external peripheral of drum. Thus, the crushing drum crush the materials and push them to screw conveyor (a). The center part was the separating portion, it has rotary hollow cylindrical tubular steel with big holes to allow the seeds pass but, the skin-releasing were thrown out from the cylindrical end. Whereas the seeds fill down to screw conveyor (b) which deliver the seeds with small part and juice to second separate stage by using rotary hollow cylindrical tubular steel with small holes which throw away the small part and juice; at the moment there was current of water to wash the seeds by using washing unit, This part deliver the seeds to screw conveyor (c) which fill down the seeds to seed collection pan. This machine took the power from tractor PTO (65hp). Fig. 1 shows a photograph view of fabricated equipment, while Fig.2 Indicates a schematic diagram of that equipment.



Fig. 1: A photograph view of fabricated equipment.

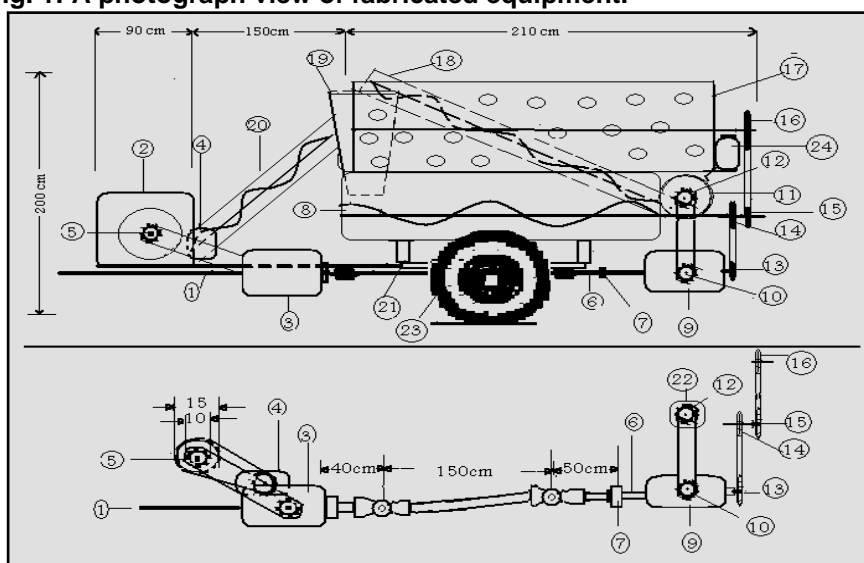

No	Part name	No	Part name
1	Power joint from pto.	13	Gear,5cm diameter
2	Feed rate box	14	Gear, 5cm diameter
3	Gear box	15	Gear,20cm diameter
4	Karona arrive motion to screw conveyor (a)	16	Gear, 5cm diameter
5	Crushing drum gear	17	Rotary hollow cylindrical tubular steel with big holes
6	Power shaft	18	Screw conveyor (c)
7	Bearing	19	Seed collection pan.
8	Screw conveyor (b)	20	Screw conveyor (a)
9	Gear box	21	chassis
10	Gear,15cm diameter	22	Corona arrive motion to screw conveyor (c)
11	Rotary hollow cylindrical tubular steel with small holes	23	Wheel
		24	Washing unit

Fig. 2: A schematic diagram and transmission system of developed machine.

So, the fabricated seed extraction equipment was planned to perform the following processes: fruit crushing, seed separation from the skin and other fruit material, skin releasing, the added part (seed washing unit) and seed pocketed. Hence, the essential elements of the fabricated equipment are as follows:-

Transmission system: Transmission system has three parts, the first part consists of respecter motion from pto which transmit the motion to gear box (3), this gear box distributed the motion to crush drum (5), screw conveyor karona (a) and power shaft, this power shaft transmit the motion to gear box (9) which distributed the motion to screw conveyor karona (b), rotary cylindrical (17) and rotary cylindrical (11). By using the front of rotary cylindrical (11), the motion can be transmitted to karona screw conveyor (c).

A drop type hopper: A drop type hopper was delivered the watermelon fruits depending on the horizontal feed rate. It is used to feed watermelon fruits to the crushing drum. This hopper has been manufactured from galvanized steel sheet by thickness of 25 mm, length of 900mm and width of 650mm and depth of 550mm.

The Crushing drum: A crushing drum has been manufactured from galvanized steel with diameter of 450 mm, length of 850 mm, mass of 50kg and the knives numbers on its external peripheral (18 knives) of crushing drum by thickness of 7 mm.

Screw conveyor (a): A screw conveyor (a) is used to transfer mixing crushing to separate unit. The screw conveyor (a) has been manufactured from sheet steel with main dimensions: length of 1500mm, diameter of 300mm, distance between two steps of 400mm and inclined on horizontal axle by angle of 17° .

First Separate unit: A first separate unit consists of cylindrical shell hollow. The cylinder was perforated with round holes with diameter of 15mm to allow seeds and things which equal seeds size to cross but the large size hurtle outward under the effect of rotating movement, it constructed from a galvanized steel with thickness of 3 mm, diameter of 600 mm , length of 1200 mm and speed of 1.36 m/s.

Screw conveyor (b): A screw conveyor (b) was put in half cylindrical chamber under the first separate unit. The cylindrical chamber has been manufactured from a steel sheet with main dimensions: length of 1350mm, diameter of 500mm, height of 500mm and thickness of 3mm. Inside this chamber there was screw conveyor (b) with main dimensions: length of 1300mm and diameter of 250mm. This part is used to transport seeds and things which mixed with it to second separate stage.

Second separate unit: It consists of cylindrical shell hollow; the cylinder is perforated with round holes by diameter of 5mm to allow small things and juice to hurtle outward but the seeds moved by rotational movement to the unit end. It constructed from galvanized steel by thickness of 1.5 mm with the main dimensions diameter of 300 mm length of 600 mm and speed of 0.93 m/s.

Washing unit (The adding part): The washing unit consists of plastic pan fill with water by capacity (60 liters), valve and hollow pipe. These parts were mounted above the second separate unit. The rotation motion of second part unit was helped the seeds to complete wash process. The discharge rates

were (0.5, 1, 1.5 and 2 L/min). The schematic diagram of these parts was shown in Fig. 3.

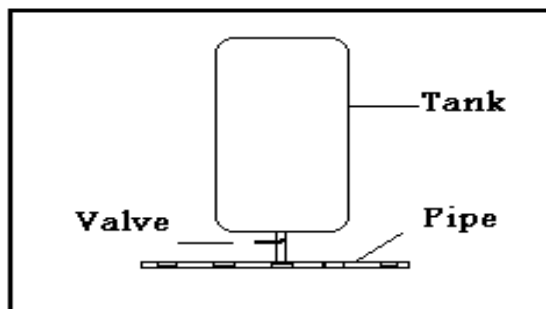

Fig. 3. A schematic diagram of washing unit.

Screw conveyor (c): Screw conveyor (c) was mounted in the end of second separate part. It was used to raise the seeds to seed collection pan and constructed from a steel sheet by thickness of 1.5mm, diameter of 200 mm and length of 1200 mm.

Seed collection pan: The pan form was parallelogram, plenty in top and narrow in the bottom. This pan has been manufactured from galvanized steel by thickness of 15 mm, length of 900mm, width of 300mm and depth of 1250mm. There was in the pan bottom mobilizing gate, this gate can be opened and closed.

Steel frame: A steel frame was fabricated from square channel iron 75 x 75 x 7 mm, and mounted on two rubber wheels. These elements were mounted on a tubular steel frame having a wall thickness of 3.3 mm. The technical specifications of the fabricated prototype are indicated in Table 2.

Table 2: The main technical specifications of the fabricated equipment.

Items	Specifications
Manufacturer	Locally small workshop
Overall length (mm)	4500
Total Width (mm)	1500
Total Height (mm)	2000
Mass (kg)	770
Source of power	Tractor P.T.O.
Crushing cylinder length (mm)	550
Drum diameter (mm)	450
Crushing knives dimensions (mm)	800 mm length x 50 mm height x 30 mm thickness.
Feeding tray dimensions (mm)	900 x 650 x 550

The preliminary experiments before modification.

After each process of crash fruits, (first separate and second separate) a sample of 1kg from out put material was taken to the laboratory separate

the broken seeds to determine the percentage of visible seed damage. The preliminary experiment appeared that: the visible seed damage after crash process was 16.3%, first separate 1.2% and second separate 0.5%. So the principal reason of visible seed damage was crash drum. Worth mention that the clearance between crash drum and concave was 1cm with drum speed of 1.4 m/s. and knives number of 19 knives, at the same time the washing efficiency was 0, 0 %.

Methods:

Some of physical properties of watermelon seeds.

Measurement of seed size and mass:

To determine the volume of the watermelon fruit, three random samples (each number 20 fruit) were taken from the entire field then; determined the different diameters of fruit by putting different lines with marker in the half fruit surface and determined the diameter (assuming the fruit is approximately spherical shape). The frequency distributions of volume of fruits were calculated as following equation (1 and 2) and Fig.4. Illustrated the method which used to measure the average diameter:

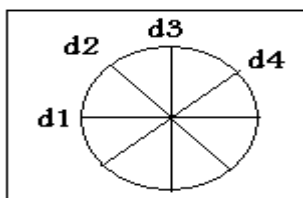

Fig .4. Diagram of distribution diameters on the surface of fruit.

$$r = \frac{d_1 + d_2 + d_3 + d_4}{8} \text{-----} 1$$

$$V = \frac{4}{3} \times \pi \times r^3 \text{-----} 2$$

Where: r = average radius, mm; $d_{1,2,3,4}$ = different diameters of fruit, mm and V= volume of fruit, mm³.

-Volumetric flow rate:

The flow rate which was flowed from hopper is very important to determine the optimum condition for keeping the seed safety. The fruits flow rate from hopper was determined by estimating the fruit volume in the orifice front, the fruits number which was delivered to crash drum, and the available rotational speed of the crash drum. Too, the following equation is useful for estimating the proper flow rate of fruits through the hopper orifice to proper drum speed, Marvin and Hyde (1987): -

$$Q = V \times N \times S \text{-----} 3$$

Where:

Q = volumetric flow rate, (m³/min); V = volume of watermelon fruit, (m³); N = number of fruits delivered to the drum with one min, and
 S = rotational speed of the drum, rev. /min.

- **The suitable fruit numbers which were used to the proper area of feed rate.**

The proper area (A_h) is useful to determine the suitable number of fruit which was fed to this area. The equation (3) shows the probable fruit number which was fed to constant proper area (A_n=1800cm²) under used different crash drum diameters and different average volumes of the fruits. So, it can be calculated as following equation (4).

$$A_h = \frac{Q}{V_L} \text{----- 4}$$

Where, V_L: the drum linear speed, m/min.

Solving equations (3) and (4) the orifice area (A_n) may be also determined as follows:

Whereas:

$$A_h = \frac{4\pi \times r^3 \times N}{3 \times R} \text{----- 5}$$

So, the suitable number of fruit can be estimated as follows:

$$N = \frac{3A_h \times R}{4 \times \pi \times r^3} \text{----- 6}$$

Where, R: the drum radius, m. and r: fruit radius, m.

Equation (6) is useful to determine the average proper number of fruit which is fed to constant area (A_h) value under different drum radius and different fruit radius. These probable were shown in Fig.5.

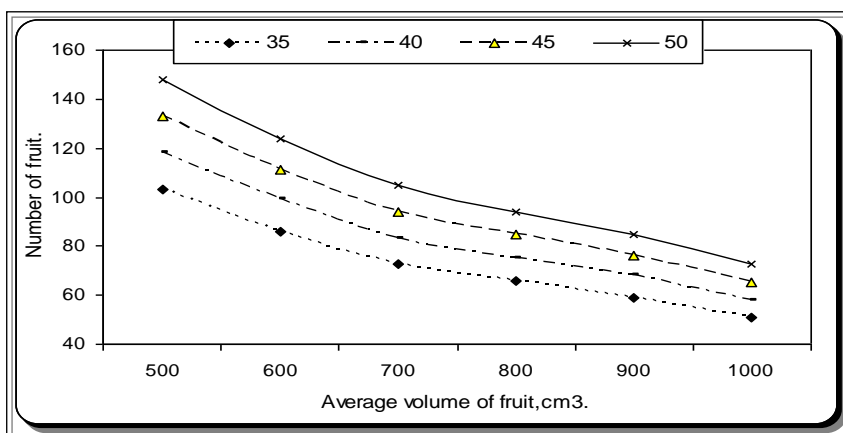

Fig.5. The proper numbers of fruits under different diameters of crush drum and different volume values of the fruits.

In addition to avoid fruits overhanging and keeping the safety of seeds, the proper fruit number with proper diameter drum was used. Whereas, the used drum diameter was (45cm) so, the permissible fruits number is (65 to 135/ min which were given by average equal to (60 to 120 kg/min).

-The knives numbers:

To determine the distance between two knives in the crash drum peripheral equation. 7 were used. And Table .3. Shows the proper number of knives under the used different measurements:

$$L = \frac{h}{360} \times u \text{ ----- } 7$$

L: distance between to knives, cm; h: measurement of curve degree; u: circle peripheral, cm.

Table.3: The proper number of knives under used different measurement of curves.

h	L	n
20	7.8	18
25	10.1	14
36	14.1	10
60	23.5	6

The proper clearance between crash drum and concave:

The proper clearance between crash drum and concave can be determined by knowing the bulk densities of the fruit. The bulk densities of the fruits were determined by dividing fruits by its volume and take the averages. Whereas, the average density which determined was (0.910 g/ cm³) by using equation (8):

$$B_d = \frac{M_s}{V_s} \text{ ----- } 8$$

B_d = The bulk density,kg/m³; M_s = Average mass of the certain quantity, kg and V_s = Average volume of the same quantity, m³

The average density is very important to determine the average permissible volumetric flow rate under used masses (60, 80, 100 and 120 kg/min). This was used to determine the suitable clearance between drum and concave. The suitable clearance(C) between drum and concave can be determined by using equations (9&10) and the calculated data were shown in Fig (5). These data show that the averages depict of clearance between drum and concave which suits the used volumetric flow rate. The illustrated data show that the suitable the range of clearance was about (1 – 3 cm).

$$T = \frac{2\pi \times r}{V_L} \text{ ----- } 9$$

Whereas:

$$C = \frac{Q_L \times T}{\text{drumlength, m} \times \text{periphelcrash, m}} \text{ ----- } 10$$

C = permissible clearance between crash drum and concave, m; Q_L = the average permissible volumetric flow rate, m^3/s ; T= time requirement for one circle, s; V_L = speed of crash drum, m/s and r = radius of crash drum, m.

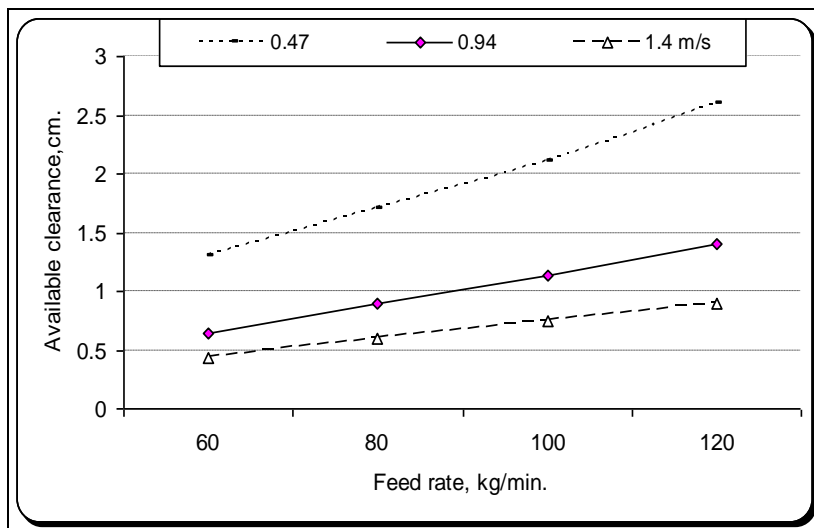

Fig.5. The average available values of drum clearance under the use of different drum speeds and feed rates.

Experimental plan.

The develop equipment has been tested and evaluated considering different knives number on crush drum of (6, 10, 14 and 18 knives), different feeding rates of (60, 80, 100 and 120 kg / min), different drum speeds of (0.47, 0.94, and 1.4 m/s) and different clearances between the concave and drum of (10, 20 and 30 mm).The effect of previous considered parameters on the performance of fabricated equipment were evaluated in terms of visible seed damage, total seed losses, energy and cost requirements.

Visible seed damage:

The visible seed damage was calculated according to *Destia and Mishra, (1990)* as follows:

$$\text{Visible seed damage, \% (Vsd)} = \frac{\text{Broken seeds mass in sample, g (M}_b\text{)}}{\text{Total seeds mass in sample, g (M}_t\text{)}} \times 100 \quad \text{---11}$$

Separation capacity:

The separation capacity of the fabricated equipment was calculated as follows:-

$$\text{Separation capacity, kg/h (C)} = \frac{\text{Seeds mass, kg (M)} \times 60}{\text{Pass time, min (T}_s\text{)}} \quad \text{-----12}$$

Seed losses:

The seeds which found mixed with peels were separated and collected manually and weighted. Then the percentages of seed losses were determined by using the following relationship:

$$\text{Seed losses , \%} = \frac{M_1}{M_1 + M_2} \times 100 \text{ -----13}$$

Where:

M_1 =Seed mass mixed with the expelled peels, g.

M_2 = Seeds mass clean from output opening, g.

-Cleaning efficiency:

After each treatment a sample of 1kg from out put material was taken into laboratory and separated to clean seeds (M_c) which collected from seeds opening, the seeds which expelled with the peels and foreign matters were picked (M_L) and weighed all of them. So, the cleaning efficiency was calculated according to the following equation:

$$\text{The cleaning efficiency , \%} = \frac{M_c}{M_c + M_L} \times 100 \text{ ----- 14}$$

-Washing efficiency:

After each treatment a sample of 1kg from out put seeds opening was dried in the sun and taken into laboratory to separate the clean seeds (S_c), the seeds which covered with the flesh (S_d) and weighed all of them. So, the washing efficiency was calculated according the following equation:

$$\text{The washing efficiency, \%} = \frac{S_c}{S_c + S_d} \times 100 \text{ -----15}$$

$$\text{Washing productivity, kg/L} = \frac{\text{Machine productivity, kg / min .}}{\text{Washingrate, L / min .}} \text{ -----16}$$

Energy consumed:

To estimate the engine power during extracting process, the decrease in fuel level accurately measured immediately after each treatment. The following formula was used to estimate the engine power. Hunt (1983).

$$E_p = (F_c \times \frac{1}{3600}) PE \times L.C.V. \times 427 \times \eta_{th} \times \eta_m \times \frac{1}{75} \times \frac{1}{1.36} \text{ -----17}$$

Where:

E_p = Engine power, kW; F_c = The fuel consumption, (l/h); PE = The density of fuel, (kg/l), (for Gas oil = 0.85); $L.C.V$ = The lower calorific value of fuel, (11.000 k.cal/kg); ζ_{th} = Thermal efficiency of the engine (35 % for Diesel); 427= Thermo-mechanical equivalent(Kg.m/k.cal) and ζ_m = Mechanical efficiency of the engine (80 % for Diesel).

Hence, the specific energy consumed can be calculated as follows:-

$$\text{Consumed energy, kW.h/ton} = \frac{\text{Enginpower, kW}}{\text{Machineproductivity, ton / h}}$$

-Human energy:

For each operation the consumed human energy (was estimated based on the power of three laborers, which considered being about 0.1 hp, using the following equation of *chancellor, 1981*.

$$E_H = \frac{0.1 \times 0.0746 \times N_L}{E_C} \dots\dots (\text{kW.h / ton}) \dots\dots\dots 19$$

Where:

E_H = Machine productivity, ton/h; N_L = Number of laborers, man;
 0.0746 = Coefficient of changing from hp to kW and 0.1 = hp of agricultural laborer.

Total costs:

Total cost was determined by using the following equation (*Awady, 1978*):-

$$C = \frac{p}{h} \left(\frac{1}{a} + \frac{i}{2} + t + r \right) + (0.9 \times w \times S \times F) + \frac{m}{144} \dots\dots 20$$

Where:-

C = Hourly cost, L.E/h; P = Price of machine, L.E;
 h = Yearly working hours, h/year; a = Life expectancy of the machine, h;
 i = Interest rate/year; F = Fuel price, L.E/l;
 t = Taxes, over heads ratio; r = Repairs and maintenance ratio;
 m = Monthly average wage, L.E; 0.9 = Factor accounting for lubrications;
 W = Engine power, hp; S = Specific fuel consumption, l/hp.h;
 144 = Reasonable estimation of monthly working hours.

Whereas:

Unit costs (U_c): The unit costs, (LE/ton) was estimated as follows:-

$$\text{Unit cost, LE/ton} = \frac{\text{Total cost, LE/h}}{\text{Machine productivity, ton/h}} \dots\dots\dots 21$$

Estimation of criterion cost: The criterion cost was estimated according to the following equation (*Awady et al, 1982*).

$$C_r = U_c + L_c + \text{Vis}_c \dots\dots\dots 22$$

where: -

C_r = The criterion cost, LE/ton;
 U_c = Unit cost, LE/ton;
 L_c = Losses cost, LE/ton, and
 Vis_c = Visible damage cost, LE/ton.

RESULTS AND DISCUSSIONS

The discussion will cover the obtained results under the following items:

Visible Seed Damage:

It can be seen in Fig.6 that by increasing feed rate from 60 to 120 kg/min., the visible seed damage was decreased by average 1.25%. On the other hand, by increasing drum speed from 0.47 to 1.40 m/s; the visible seed damage was decreased by average of 0.65 %. Too, by increasing knives number on peripheral crash drum from 6 to 18 knives the visible damage increased by average of 1.50 %. It is evident that 6 knives gave the lowest values of visible seed damage of 1.87% compared with the other knives numbers of 10, 14 and 18 knives at the average of feed rates and drum speeds. Referring to the data in Fig. 6, by increasing the drum-concave clearance from 10 to 30 mm at the average effect of other variables tended to decrease the visible seed damage by average 1.13 %. That was may be due to the decrease of impact forces between watermelon seeds and knives too, the high dense of seeds which were exposed to impact with separate drum rotation.

Seed Losses:

The data in Fig.7 show that the increase of feed rate from 60 to 120 kg/min. tends to increase seed losses; from these data it can be observed that the increase in feed rate tends to increase the seed losses at all variable levels. When, the feed rate increased from 60 to 120 kg/min the seed losses increased by average 2.15%. It can be stated that the drum speed had considerable effect on the seed losses. On the whole, by increasing drum speed from 0.49 to 1.40 m/s the seed losses increased by average 1.90%. This trend may be due to the increase of the impact force between knives and seeds which gave the seeds more kinetic energy. This was due to increase in the push rate of the seeds with skin. The minimum seed losses percentage was associated with 14 drum-knives compared with the other knife numbers (6, 10 and 18 knives). However, increasing or decreasing the drum-knives number more or less than 14 knives tends to increase seed losses. The seed losses increased by average 0.54% as the drum-knives number decreased from 14 to 10, and increased by 1.15% as knives number increased from 14 to 18 knives. In addition to increase drum-concave clearances from 10 to 30 mm seed losses increased from 3.50 to 4.31%. It seems that increasing the drum-concave clearance tends to increase the seed losses at any tested level of feed rate, drum speed, and drum-knives number.

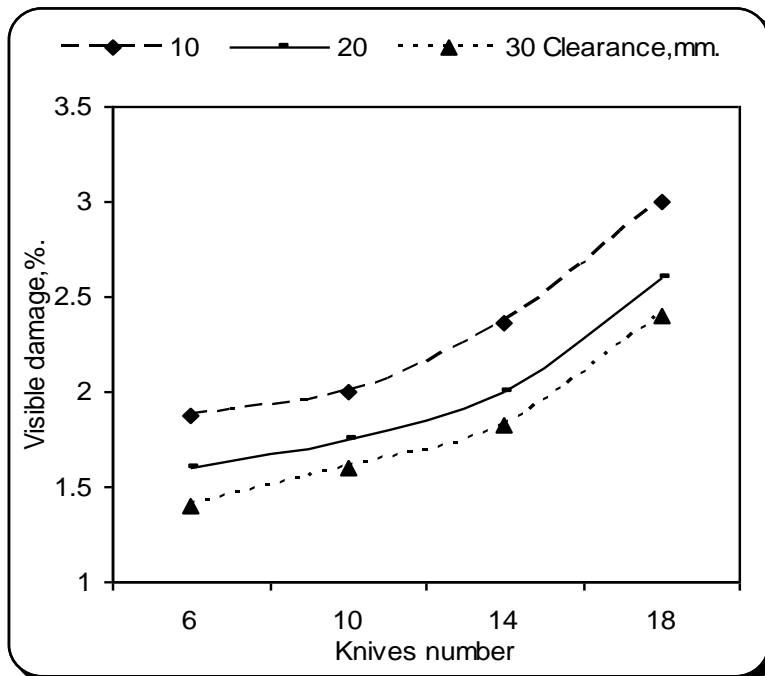
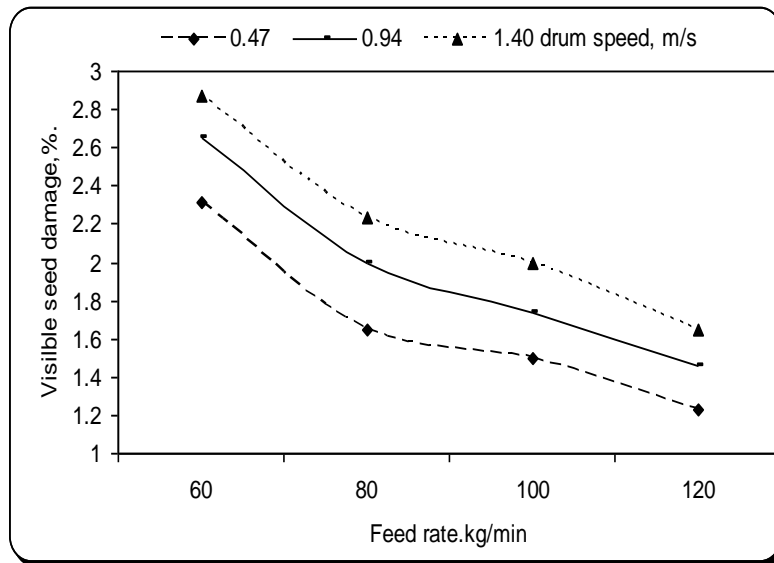

Fig.6. Effect of feed rate, drum speed and clearance between crush drum and concave on visible seed damage.

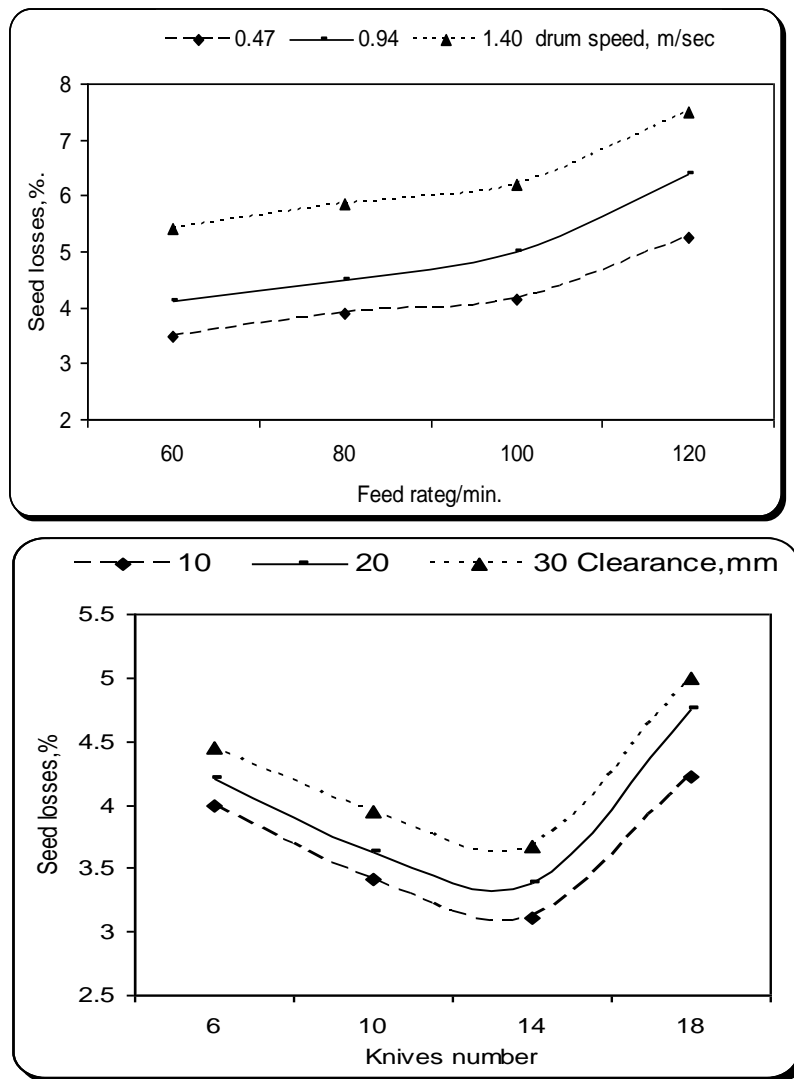

Fig. 7. The effect of drum speed and clearance, knives number and feed rate on seed losses rate.

Machine productivity:

The data in Fig.8 show that the increase in feed rate from 60 to 120 kg/min tends to increase machine productivity by average of 148.79 to 279.05 kg/h. It is clear that the machine productivity increased by average of 147.69 % when the feed rate increased from 60 to 120 kg/min at same conditions. Too, the data were indicated that the average values of productivity slightly decreased when drum speed ranged from 0.47 to 1.40 m/s. This was may be

attributed to increase the drum speed and decrease available time for passing seeds through concave holes. On the other hand the machine productivity was decreased when drum-knives number increased more than 14 knives for all the other parameters this was due to the large piece of peel with flesh so, it is facility to separate it while the 18 drum-knives gave small pieces of peel mixed with seeds which increased the losses ratio. This result may be due to decrease the adhesion force between seeds and flesh. Too, the minimum values of seed losses were associated with 14 drum-knives compared with the other numbers of knives (6, 10 and 18 knives).The results indicated that by increasing the drum-concave clearance from 10 to 30 mm tended to decrease the machine productivity from 245.5 to 238.3 kg/h.

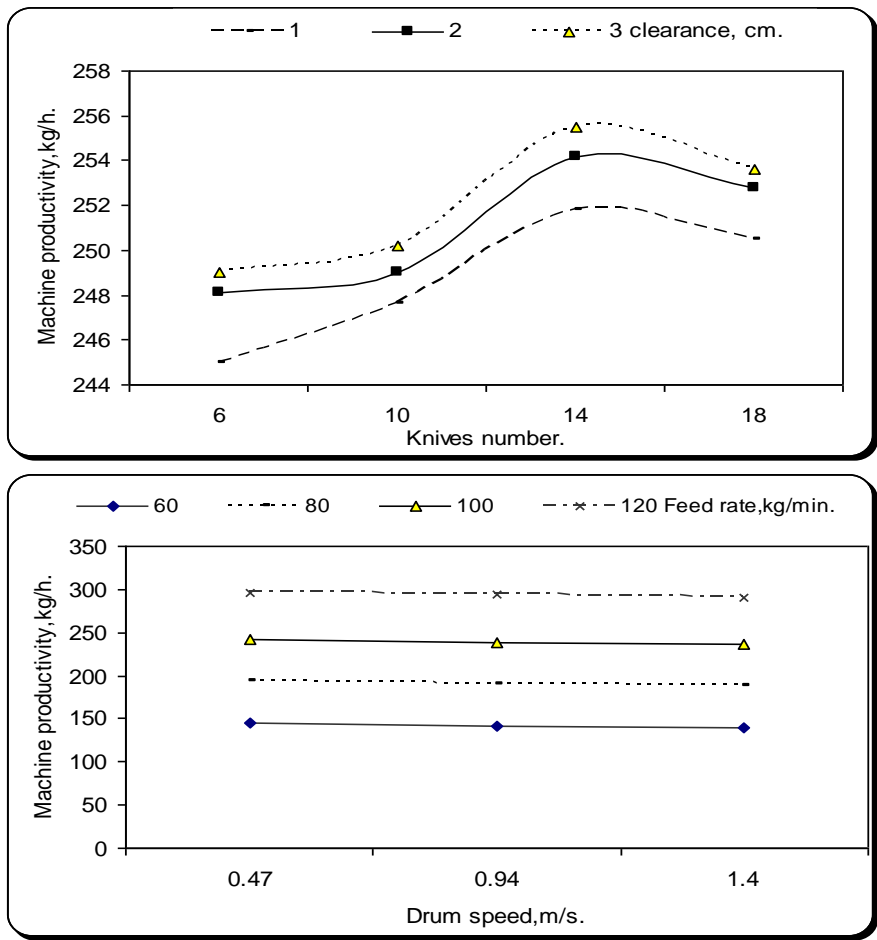

Fig.8. Effect of feed rate, knives number, drum-concave clearance and speed on machine productivity.

Washing efficiency:

The effect of feed rate, drum speed and water flow rate of washing water on washing efficiency of watermelon seeds after extracting operation was indicated in Table 4 and Fig. 9. With stable knives number 14 knives; the washing efficiency was decreased by average of 2.8% when the drum speed was increased from 0.46 to 1.4 m/s. While, the obtained values of washing efficiency was decreased by average 1.1% when the water feed rate increased by 20 kg/min. But when water flow rate increased by average 0.5 L/min the washing efficiency was increased by average 1.2%. Whereas the maximum value of washing efficiency was 98.0% with drum speed of 0.46, drum clearance of 3 cm, water flow rate of 2 L/min. and feed rate of 60 kg/min. Too, the minimum value of 88.7 % was obtained under used concave clearance of 1 cm, drum speed of 1.4m/s, flow rate 0.5 L/min and feed rate of 120kg/min; this was may be increased the crashing process of seeds with peel due to more adhesion material with seeds so, the washing productivity was 1.25 kg/L.

Cleaning Efficiency:

The effect of feeding rate, knives number, drum speed and drum clearance on cleaning efficiency of watermelon seeds after extracting operation was indicated in Table 5.and Fig. 10. Cleaning efficiency was decreased by average of 2.2% when the drum speed was increased from 0.46 to 1.4 m/s. Too, when drum clearance decreased by 1cm cleaning efficiency was decreased by average 2.1%.Whereas the maximum value of clearance efficiency was 93.8% with concave clearance of 3 cm, drum speed of 0.46, knives number of 14 and feed rate of 60kg/min. Too, the minimum value of 79.0% was obtained under used concave clearance of 1 cm, drum speed of 1.4m/s, knives number of 6 and feed rate of 120kg/min.The decrease of cleaning efficiency may be due to the insufficient time to clean the extracting seeds with increasing the feed rate and drum speed.

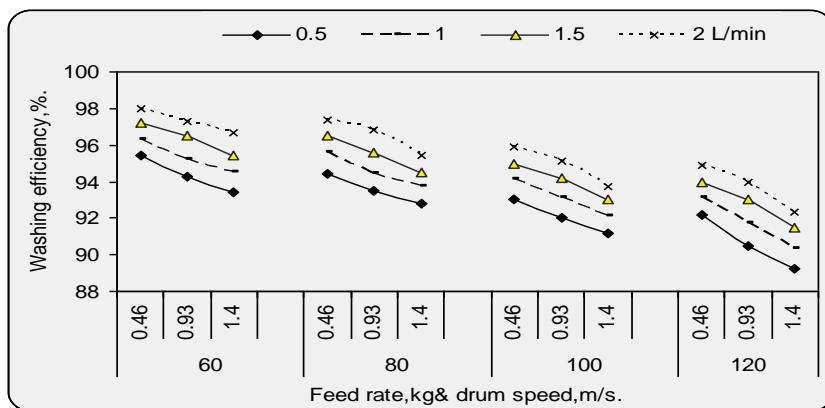

Fig.9. the effect of feed rate, drum speed and flow rates on washing efficiency.

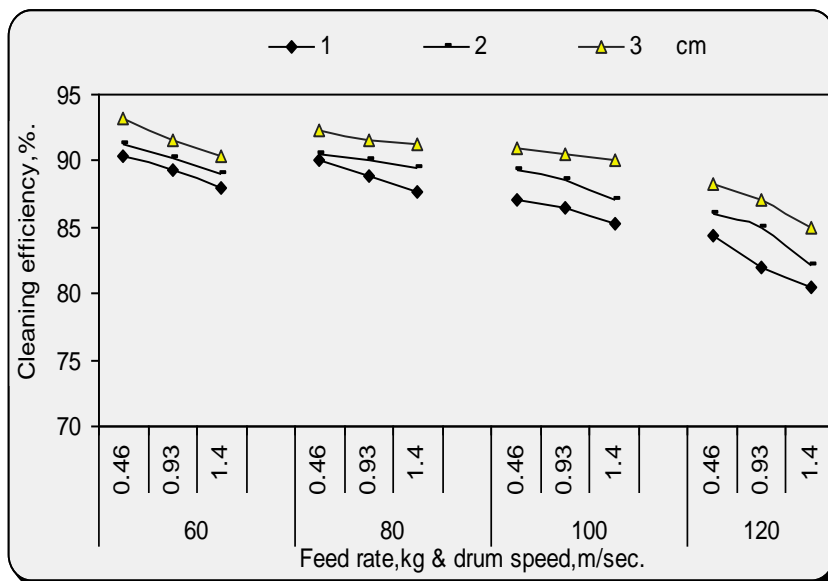

Fig.10. Effect of drum speed, drum clearance and feed rate on cleaning efficiency

Consumed power:

The average values of consumed power as affected by feed rates and drum speeds is plotted in Table 6. By decreasing feed rate from 120 to 60 kg/min, the power consumed decreased by average 24.01%. As the feed rate was increased the power consumed for extracting machine was increased at same levels of variables. Too, by decreasing the drum speeds from 1.40 to 0.47 m/s., the power consumed was decreased by average 52.48%. That result trend may be due to increase the power required for more quantity of material.

Table. 6: The effect of feed rate and drum speed on consumed power.

Feed rate, kg/min.	Consumed power, kW				Energy requirements, kW.h/ton			
	Drum speed, m/s.			Mean	Drum speed, m/s.			Mean
	0.47	0.94	1.4		0.47	0.94	1.4	
60	6.14	8.72	12.92	9.26	41.31	58.65	86.9	62.28
80	6.46	9.04	13.56	9.68	32.58	45.61	68.41	48.86
100	7.11	9.69	14.54	10.44	28.69	39.11	58.67	42.15
120	8.08	10.67	16.6	11.78	27.18	35.88	55.82	39.62
Mean	6.94	9.53	14.40	10.29	32.44	44.81	67.45	48.23

Cost analysis

Fig.11. shows that the net profit of extracting machine was affected by feeding rate and drum speed. The Maximum value of net profit (1052 LE/ton) was achieved at feeding rate of 60 kg/min and drum speed of 1.4m/s. While, the least net profit was estimated at 120 kg/min feed rate for all different

ranges of drum speed. The data also indicated that by increasing drum speed from 0.47 to 1.40 m/s leads to decrease net profits by about 2.4 % under all different values of feed rates.

Comparison between manual and mechanical extraction of watermelon seeds.

The manual watermelon seed extraction cost was estimated according to the use of manual method for extracting watermelon seeds. Seed extraction of one feddan required 15 labors as an average; each labor cost 60 LE per day. Also the total seed losses for manual extracting were 2.7 % represented about 178 LE/fed, these losses were due to throw the seeds around the extract pan. Thus, the manual extraction of watermelon seeds cost about 1078 LE per feddan and 2695LE/ton. By comparing data of mechanical and manual watermelon seed extraction cost, the developed unit save the costs by about 61.4 % and decreased the costs per feddan by 367.5LE compared with the manual extraction.

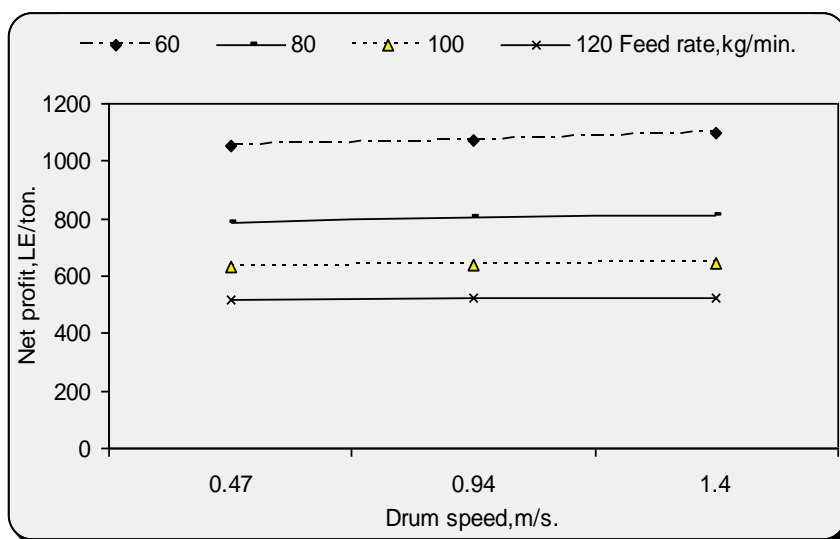

Fig.11. Effect of drum speed, and feed rate on net profit.

CONCLUSION

The test of a locally fabricated extraction machine after each process shows that high visible seed damage after crash process by average of 16.3%, first separate 1.2% and second separate 0.5%. So the principal reason of visible seed damage was crash drum. Added to that the extracted seeds were in need to washing process. The developed equipment has been tested and evaluated considering different knives number on crush drum of (6, 10, 14 and 18 knives), different feeding rates of (60, 80, 100 and 120 kg / min), different drum speeds of (0.47, 0.94, and 1.4 m/s) and different clearances between the concave and drum of (10, 20 and 30 mm).The results of the developed machine illustrated that the 6 knives gave the lowest

values of visible seed damage by average of 1.87% compared with the other knives numbers of 10, 14 and 18 .By increasing the drum-concave clearance from 10 to 30 mm at the average effect of the other variables tended to decrease the visible seed damage by average of 1.13%.The data show that the seed losses increased by average of 2.15%; when feed rate was increased from 60 to 120 kg/min. On the whole, by increasing drum speed from 0.49 to 1.40 m/s the seed losses increased by average of 1.90%. The minimum seed losses percentages were associated with 14 drum-knives compared with the other knife numbers (6, 10 and 18 knives).the increased in feed rate from 60 to 120 kg/min tends to increase machine productivity from of 148.79 to 279.05 kg/h. Too, the data indicated that the average values of productivity slightly decreased when drum speed ranged from 0.47to 1.40 m/s. the minimum values of seed losses were associated with 14 drum-knives compared with the other numbers of knives (6, 10 and 18 knives).The results indicated that by increasing the drum-concave clearance from 10 to 30 mm tended to decrease the machine productivity from 245.5 to 238.3 kg/h. washing efficiency was decreased by average of 2.8% when the drum speed increased from 0.46 to 1.4 m/s. while, the obtained values of washing efficiency decreased by average of 1.1% when feed rate increased by 20 kg/min. But when water flow rate increased by average of 0.5 L/min the washing efficiency increased by average 1.2%.The maximum value of cleaning efficiency was 93.8% with concave clearance of 3 cm, drum speed of 0.46, knives number of 14 and feed rate of 60kg/min. Too, the minimum value of 79.0% was obtained under concave clearance of 1 cm, drum speed of 1.4m/s, knives number of 6 and feed rate of 120kg/min. By decreasing feed rate from 120 to 60 kg/min, the power consumed decreased by average of 24.01%. Too, by decreasing drum speeds from 1.40 to 0.47 m/s., the power consumed decreased by average of 52.48%. The Maximum cost value of 1052 LE/ton was achieved at feeding rate of 60 kg/min and drum speed of 1.4m/s. While, the least cost was estimated at 120 kg/min feed rate for all different ranges of drum speed. The developed unit saves about by 61.4 % compared to the manual extraction.

REFERENCE

- Abou-Elmagd, A.E.; A.S. Hamam; M.A. EL-Saadany and S.A. El-Kawaga (2002): Design of a cone-end detacher for orange picking. *Misr. J. Ag. Eng.*, 19(2): 491-507.
- Abdel- Mageed,H; Abou-Elmagd, A.E.and I.F. Sayed (2006): Construction and performance of a machine for separating watermelon seeds. *Misr. J. Ag. Eng.* 19(2): 491-507.
- Abu Shieshaa. R, R. Kholief, A. A. El Meseery(2006): A study of some physical and mechanical properties of seed melon seed . *Misr. J. Ag. Eng.*, 24(3): 575-592.
- Akubuo, C.O. and E.U. Odigboh (1999): Egusi fruit coring machine. *J. Agric. Eng. Res.*, 74: 121-126.

- Awady, M. N (1978):Tractor and farm machinery. Txt bk.,col. Agric., Ain-Shams Univ. (FAO). J.
- Awady, M. N; E. Y. Ghoneim and A. I. Hashish (1982): A critical comparison between wheat combine harvesters under Egyptian conditions. R. S. No. 1920, Ain-Shams Univ. (FAO). J.
- Chancellor, W.I. (1981): Substituting information for energy in agriculture. Trans. ASAE, (5): 802-807.
- Desta, K.D. and T.W. Mishra (1990):Development and performance evaluation of Sorghum thresher. AMA, 21(3): 33-37.
- George, R. A. T. (1985): Vegetable seed production. London. 318 p.
- Hunt, D. (1983): Farm power and machinery management 8th Ed., Iowa state Univ., Press Ames, U.S.A.
- Humeida, M.A. and A.I., Hobani. (1993): Physical properties of pomegranate fruits. J. King Saud Univ. Vol.5., Sci. (2).165-175.
- Matouk, A.M.; A.M. El-Gindy; Y.M. El-Hadidi; E.A. Amin and M.M. El-Rahman (1999): Evaluating the effect of some mechanical parameters on handling characteristics of sphere-like crops. Misr J. Ag. Eng., 16 (4): 701-719.
- Marvin J. P. and Hyde G.M. (1987): Algorithms for determining shape of tuber and seed piece. Trans. of the ASAE, Vol.30 (2).
- Vergano, P.J.; R.F. Testion; A.C. Choudhari and W.C. Newall. (1992): Peach vibration bruising: The effect of paper and plastic films between peaches. J. of Food Quality 15(3):183-197.

تطوير وتقييم آلة محلية الصنع لإستخلاص بذور بطيخ اللب

شرين فؤاد عبد الحميد محمد

معهد بحوث الهندسة الزراعية- الدقى - الجيزة- مصر

يهدف البحث إلى تحديد أهم المشاكل التي تواجه استخدام الآلة إستخلاص بطيخ اللب المصنعة محليا ووضع الحلول النظرية وتقييمها عمليا للتغلب على تلك المشاكل . وحيث ان الآلة موضع الدراسة تقوم بعمليات تكسير وسحق ثمرة لب البطيخ وكذلك عمليات فصل البذور عن القشرة و الشحم ثم طردها و تنظيف البذور وتجميعها من فتحة لخروج البذور. ولكن ينتج عن استخدامها مشكلتين أساسيتين الأولى: ارتفاع نسبة الكسر في البذور مقارنة بالطريقة اليدوية والثانية: البذور الناتجة تحتاج الى عملية غسيل يدوية للتخلص من بقايا الشحم الملتصق بها مما يقلل من كفاءة الآلة. ولذلك تمت تجربة مبدئية لتحديد الجزء في الآلة المسئول عن ارتفاع نسبة الكسر في البذور فتم أخذ عينات من البذور عقب العمليات المختلفة (التكسير والسحق- الفصل المرحلة الاولى والثانية) ووجد ارتفاع نسبة الكسر في البذور عقب عملية تكسير وسحق الثمار في درفيل السحق حيث وصلت النسبة الى ١٦,٣% وذلك تحت القياسات التصنيعية للآلة وهي استخدام خلوص درفيل ١٠مم وسرعة درفيل ٤,١م/ث و عدد السكاكين على محيط درفيل السحق ١٩ سكين ولذلك تم تطبيق بعض الدراسات النظرية لتحديد المجال المناسب لكل من معدلات التلقيح المناسبة لآلة السحق- الخلوص بين درفيل السحق والصدر- المسافات الصحيحة لسكاكين القطع على درفيل السحق) كما تم اضافة وحدة لغسيل للبذور عقب عملية الفصل الثانية وبناءا على هذه الدراسة تم تقييم الآلة تحت المعاملات التالية:

- أربعة معدلات تلقيح (٦٠-٨٠-١٠٠-١٢٠كجم/د)
 - ثلاث قيم للخلوص بين درفيل السحق والصدر (١٠-٢٠-٣٠ مم)
 - ثلاث سرعات لدرفيل السحق (٠,٤٧ - ٠,٩٤ - ١,٤ م/ث)
 - عدد السكاكين على محيط درفيل السحق (٦-١٠-١٤-١٨ سكين)
- وتتكون المعدة موضوع البحث من الوحدات التالية:-**

- **وحدة القطع والفصل: وهي عبارة عن:**
- **قادوس التغذية:** اناء على شكل شبة منحرف مقسم الى جزئين جزء لاستقبال الثمار ولآخر يوجد به درفيل السحق.
- **درفيل السحق:** اسطوانى الشكل قطره ٤٥ سم بطول ٨٥ سم يتم تثبيت على محيطه سكاكين القطع
- **وحد الفصل الأولى:** تتكون من اناء اسطوانى الشكل مثقب بثقوب قطرها ١٥ مم وهي اكبر من طول البذرة ومنصلة من الجهة الأولى ببريمة النقل والأخرى مفتوحة الى الخارج وتقوم الوحدة بحركة دورانية مما تؤدي الى اندفاع البذور وما يساويها الى أسفل من خلال الثقوب والقشرة وما يساويها تندفع للخارج بقوة الدفع المركزى كما يوجد أسفل وحدة الفصل الأولى اناء على شكل نصف اسطوانة يوجد بداخله بريمة لنقل الثمار الى المرحلة الثانية من الفصل
- **المرحلة الثانية من الفصل:** وهي عبارة عن اناء اسطوانى الشكل مثقب بثقوب قطرها ٥ مم وهي أقل من عرض البذرة و يتحرك حركة دورانية يتم من خلالها التخلص من الاحجام الصغيرة والعصير وخلال هذه المرحلة تم تركيب أعلاها وحدة الغسيل
- **وحدة الغسيل:** تتركب من اناء اسطوانى الشكل سعة ٦٠ لتر متصل من أسفل بأنبوبة أفقية وأخرى عمودية عليها بطول ٦٠٠ مم مثقب بثقوب بقطر ٢ مم.
- **بريمة الرفع:** تقوم باستقبال الثمار من المرحلة الثانية من الفصل لتوصيلها الى غرفة التعبئة.
- **وحدة نقل القدرة والتحكم فى السرعات:**
- يتم نقل القدرة من PTO الجرار إلى الآلة ثم إلى كل أجزاء الآلة والتحكم فى السرعات يتم عن طريق مجموعة من السيور والعجلات المسننة .
- وقد أظهرت النتائج المتحصل عليها الآتي:**
- أدت زيادة معدل التلقيح من ٦٠ إلى ١٢٠ كجم ثمار/دقيقة إلى انخفاض كل من التلف الظاهري للبذور، وكفاءة التنظيف، وصافي العائد بمعدل ١.٢، ٧.٩، ٥١.١% على الترتيب. بينما أدت إلى زيادة كل من معدل فقد البذور، وإنتاجية الآلة، والطاقة المستهلكة بمعدل ٢.٣، ٤٦.٦٨، ٢٤.٠١% على الترتيب.
- أدى تشغيل درفيل السحق على سرعة عالية (١.٤ م/ث) إلى زيادة كل من التلف الظاهري للبذور، ومعدل فقد البذور، والقدرة المستهلكة بمعدلات ٢.٨٧، ٥.٢%، ١٦.٦ كيلوات. بينما أدت إلى انخفاض كل من إنتاجية الآلة، وكفاءة التنظيف وصافي العائد بمعدلات ٣.٢٥، ١٣.٥٩، ٥.٩٦% على الترتيب.
- يوصى باستخدام عدد أربعة عشر سكين على محيط درفيل السحق حيث تسبب نقص أو زيادة عدد السكاكين عن ١٤ سكين إلى زيادة معدل فقد وكسر البذور ونقص إنتاجية المعدة موضوع البحث.
- أعلى كفاءة لتنظيف البذور تم الحصول عليها باستخدام الخلووص ٣ سم لدرفيل السحق ويعمل على سرعة ٠.٤٧ م/ث.
- أعلى كفاءة لغسيل البذور تم الحصول عليها باستخدام الخلووص ٣ سم لدرفيل السحق ويعمل على سرعة ٠.٤٧ م/ث وتصرف خزان الغسيل ٢ لتر/د ونتيجة غسيل ١.٢٥ كجم/لتر .
- توصى الدراسة: باستخدام الآلة المصنعة بخلوص درفيل ٣ سم وسرعة درفيل أقل من ١.٤ م/ث وعدد سكاكين القطع على محيط الدرفيل ١٤ سكين واستخدام وحدة الغسيل اثناء مرحلة الفصل الثانية بمعدل تصرف ٢ لتر/د .

