

SELF-COMPACTING CONCRETE

HOW TO PRODUCE IT?

الخرسانة ذاتية الدمك - كيف تنتج ؟

by

Mahmoud Imam

Associate Professor, Structural Engineering Dept., Mansoura University.

خلاصة — الخرسانة ذاتية الدمك هي خرسانة لها درجة عالية من السيولة والإسباب كما أن لها مقاومة عالية للإلصاق الحبيبي ويمكن صبها بنجاح في القطاعات الضيقة والمزدحمة بحديد التسليح وذلك بدون الإسراع بأى وسيلة دمك خارجية. وتعتبر الخرسانة ذاتية الدمك نتاج التقدم التكنولوجي في مجال إضافات الخرسانة حيث تعتبر كل من إضافات تصسين اللزوجة وإضافات تقليل ماء الخلط هما العنصرين الأساسيين اللذين لهما إلتزام هذه الخرسانة. يقدم هذا البحث محاولة لإنتاج الخرسانة ذاتية الدمك باستخدام المواد المحلية المتاحة في مصر كما يدرس المتطلبات الخاصة للغالبية للتشغيل وكذلك الإختبارات الخاصة والضرورية لهذه الخرسانة. يتضمن البرنامج العملي صب وإختبار عدد 18 خلطة مختلفة. وقد تم دراسة تأثير المتغيرات الستة الآتية: محتوى الأسمنت ، نوع المواد الناعمة ، محتوى بودرة الحجر الجيري ، جرعة إضافات تصسين اللزوجة ، جرعة إضافات تقليل ماء الخلط ، وجرعة إضافات الهواء المحبوس. ولقد تم إجراء وشرح ثلاث إختبارات خاصة بهذه الخرسانة وهي إختبار الإسباب وإختبار القمع على شكل حرف V وإختبار سعة الملء. وقد أعطت الخلطات نتائج مناسبة جداً تشجع على إستخدام هذه الخرسانة في التنفيذ. فقد وصلت قيمة إسباب الهبوط إلى 850 مم ، كما بلغت سعة الملء 100% ، وزمن المرور من القمع 7 ثوان فقط. وبصفة عامة فلقد أظهرت الإختبارات إمكانية صناعة الخرسانة ذاتية الدمك بالمواد المحلية بدرجة نجاح عالية.

ABSTRACT — Self-Compacting Concrete (SCC) is a new type of concrete that can be spread in heavily congested regions under its own weight, and without vibration. It has excellent deformability and high resistance to segregation and bleeding. SCC is a result of the technological advancement in the area of concrete admixtures. This paper presents an attempt to produce SCC from the available materials in Egypt and investigates the workability requirements and tests of SCC. The experimental program consists of casting and testing eighteen SCC-mixes. Six different parameters are considered as; cement content, type of fine materials, content of limestone powder, dosage of viscosity-enhancing admixtures, dosage of air-entraining admixtures, and dosage of superplasticizers. The test results indicated that viscosity-enhancing admixture together with the new generation superplasticizer based on a modified polycarboxylic-polyether are the keystone for producing SCC. Three main tests which differentiate SCC from ordinary concrete were carried out and explained in this paper. These tests are slump-flow test, V-funnel test, and filling-capacity test. SCC-mixes provided slump flow up to 850 mm, filling capacity up to 100%, passing time up to 7 sec., and compressive strength up to 36.3 MPa. These results are quite appropriate for using SCC in any construction site. It is believed that SCC is a promising construction material in the near future.

KEYWORDS --- Self-compacting concrete, flowable concrete, viscosity-enhancing admixture, air entrainment, slump flow, filling capacity test, V-funnel test, segregation, bleeding, superplasticizer, limestone powder.

INTRODUCTION

Factors affecting the workability of a concrete depend mainly on the type of construction, methods of placing and compacting, the complexity of form shape, and the degree of reinforcement congestion. In most reinforced concrete members with high ratio of reinforcing bars such as mat foundations and structural frame, there is an increasing need to use high flowable concrete to insure proper filling of formworks. When the concrete is a conventional concrete, then the vibration becomes an important part of the business. More vibrations can lead to segregation, bleeding, and blockage of the concrete when flowing across narrow spaces between reinforcement. As a result, improper bond to reinforcing steel and inadequate mechanical properties and durability may be attained. In such a case, Self-Compacting Concrete can be a solution.

The original idea of self-compacting concrete was published by the research team of professor Okamura at the University of Tokyo, Japan [1-3]. In their research, this concrete was called high-performance concrete (HPC). Some European and Canadian researchers insisted that the term "high performance" should refer only to hardened concrete and that the concrete with high fluidity proposed in Japan should be excluded from HPC and it was then called "Self-Compacting Concrete (SCC)", for which RILEM organized a new committee [4]. Since then, several researchers all over the world have concerned with the investigation and production of SCC [5-13]. However, the development of SCC is a result of the technological advancement in the area of concrete admixtures. SCC is a new type of concrete that has excellent deformability and high resistance to segregation and bleeding. It can be spread in heavily congested regions under its own weight, and achieve good consolidation without vibration. It was employed in several construction projects [14-18].

SCC is obtained by the addition of a new generation superplasticizer which is based on a modified polycarboxylic polyether. A viscosity-enhancing agent is necessary to obtain adequate segregation resistance. The use of high content of fine materials such as limestone powder, granulated blast furnace slag powder, and/or silica fume or fly ash is also required. Limited coarse aggregate content is also advisable. The procedure to design the required SCC-mixture is totally different from that of conventional concrete, since segregation resistance and flowability characteristics have priority over the concrete strength. However, the main advantages of SCC are:

- Easily placed in thin-walled elements or elements with restricted access.
- Reduced noise and vibration during placement.
- Results in more durable concrete.
- Less leveling and better appearance on concrete surface.
- More concrete placement in less period of time.
- Very flowable concrete, no need to add any water in the job site.
- Cost savings through reduced equipment and less labor.

This paper presents an attempt to produce SCC from the traditional materials in Egypt and investigates the workability requirements and tests of SCC.

Table 1 Constituents of Different Trial Batches of Self-Compacting Concrete.

Mix	Mix Proportions for About One Cubic Meter of Self-Compacting Concrete										
	Cement kg	L.S.P. kg (%)	F.S. kg (%)	Sand kg (%)	Gravel kg (%)	Gravel m ³	HRWR kg	VEA kg	AEA gm	Water kg	w/c
M1	450	0 (0)	0	630 (35)	1170 (65)	0.70	9	2.25	0	176.2	0.39
M2	450	090 (05)	0	630 (35)	1080 (60)	0.65	9	2.25	0	202.5	0.45
M3	450	180 (10)	0	630 (35)	990 (55)	0.59	9	2.25	0	212.5	0.47
M4	450	270 (15)	0	630 (35)	900 (50)	0.54	9	2.25	0	237.5	0.53
M5	450	360 (20)	0	630 (35)	810 (45)	0.49	9	2.25	0	271.5	0.60
M6	450	450 (25)	0	630 (35)	720 (40)	0.43	9	2.25	0	252.5	0.56
M7	450	450 (25)	0	630 (35)	720 (40)	0.43	9	0.0	0	202.5	0.45
M8	400	282 (15)	0	660 (35)	940 (50)	0.56	8	2.00	0	225.0	0.56
M9	450	0 (0)	270 (15)	630 (35)	900 (50)	0.54	9	2.25	0	221.5	0.49
M10	450	270 (15)	0	630 (35)	900 (50)	0.54	12	0.0	0	202.5	0.45
M11	450	270 (15)	0	630 (35)	900 (50)	0.54	12	2.25	0	202.5	0.45
M12	450	270 (15)	0	630 (35)	900 (50)	0.54	12	4.50	0	250.0	0.56
M13	450	270 (15)	0	630 (35)	900 (50)	0.54	9	4.50	0	254.5	0.57
M14	450	270 (15)	0	630 (35)	900 (50)	0.54	9	6.75	0	275.0	0.61
M15	450	270 (15)	0	630 (35)	900 (50)	0.54	9	0.0	225	237.2	0.53
M16	450	270 (15)	0	630 (35)	900 (50)	0.54	9	2.25	225	241.9	0.54
M17	450	270 (15)	0	630 (35)	900 (50)	0.54	9	4.50	225	267.5	0.59
M18	450	270 (15)	0	630 (35)	900 (50)	0.54	9	4.50	450	275.0	0.61

L.S.P is a Limestone Powder

HRWRA is a High Range Water-Reducing Admixture

VEA is a Viscosity-Enhancing Admixture

F.S. is a Fine Sand

w/c is Water-Cement Ratio

AEA is an Air-Entraining Admixture

OBJECTIVES

The main objectives of this paper are:

- 1- To provide guidelines for proportioning SCC with local materials in Egypt.
- 2- To highlight the workability requirements needed to achieve self compaction.
- 3- To present some tests that can be used to evaluate deformability, filling capacity, and stability of SCC.

It is worth mentioning that, the properties of hardened phase of SCC are beyond the scope of this paper and will be published in the near future.

EXPERIMENTAL INVESTIGATION

Test Program

The experimental program consists of casting and testing eighteen SCC mixes. The composition and proportioning of different concrete mixes are given in Table 1. The test program was designed and arranged to determine the effect of six different parameters as; cement content, type of fine materials, content of lime-stone powder, dosage of viscosity-enhancing admixtures, dosage of air-entraining admixtures, and dosage of superplasticizers. Figure (1) gives an illustration for these variables.

Ordinary portland cement (OPC; ASTM Type I) with contents of 400, and 450 kg/m³ was adopted in this study. The fine aggregate was natural sand with a fineness modulus of 2.47, while the coarse aggregate was round gravel with 18-mm size. Two extra types of finer materials were used; natural fine sand with a fineness modulus of 1.58, and lime-stone powder with 55% of total weight passed sieve size 0.125 mm. Viscosity-Enhancing Admixture (VEA) in the form of water soluble polymers was used to increase the cohesion of concrete mixes. It was supplied as a fine light brown powder with bulk density of 0.6 kg/liter. In addition to a reference mix without VEA, three dosages of VEA were investigated as 0.5, 1.0, and 1.5% by weight of cement. A new generation superplasticizer based on polycarboxylate/polyether technology was used. It is a chloride free and supplied as an opaque white to pale amber coloured water-based liquid. This new generation superplasticizer acts on the cement particles to deflocculate and disperse them and, unlike conventional superplasticizer, maintains the dispersion for extended periods. It provides a very powerful fluidifying effect which can be used to facilitate reductions in the water content of the concrete mix. Aluminum powder with a high degree of chemical reactivity was used to generate hydrogen bubbles in the concrete and hence, the deformability of the concrete increases. Aluminum powder is a metallic material with specific surface area of about 1000 cm²/gm. The water/cement ratio of different mixes varied from 0.39 to 0.61 depending on the content of cement and different admixtures.

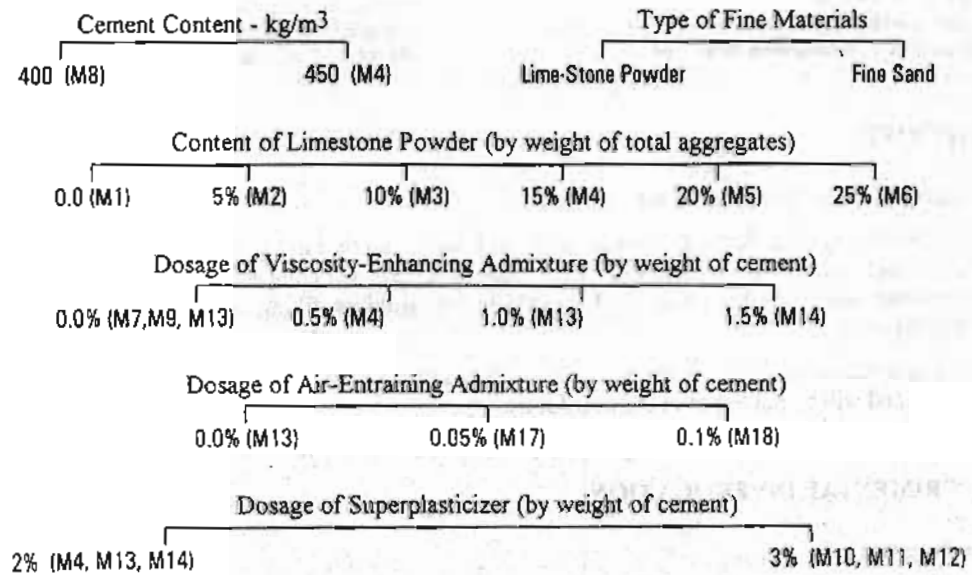

Fig. (1) Test Program.

Mix Design and Proportioning

When proportioning SCC mixes, the basic considerations are the selection of a combination of materials that will produce excellent deformability, adequate resistance to segregation, and high filling capacity and flow around obstructions without blockage. These contradicting properties are difficult to attain. However, there was a general consensus that each SCC mix has to be designed on its own merit and certainly there are matters which are considered for proportioning SCC and should be pointed out [5-8]. Among these matters:

- 1- To reduce inter-particle friction, well graded powder with a content of about 15 to 20% of total aggregates should be used. Limestone powder is usable.
- 2- To increase the deformability of the mix, coarse aggregate content should be as low as possible.
- 3- Small size of coarse aggregate particles is recommended to minimize the risk of blockage. Maximum aggregate size is limited up to 20 mm.
- 4- Balanced water/cement ratio with high-range water-reducing admixture are necessary. Polycarboxylate-polyether based superplasticizer is preferable.
- 5- To improve stability and prevent segregation, viscosity-enhancing admixture is required. The typical dosage of viscosity-enhancing admixture is 1% by weight of cement.
- 6- Increase the dosage of viscosity-enhancing admixture to minimize bleeding of SCC.
- 7- Air-entraining admixture may be carefully added to enhance the deformability of concrete. When SCC with high strength is required, air-entraining admixture is not advisable.
- 8- The content of cement and cementitious materials should be in the range from 400 to 500 kg/m³.

It can be noted that the design of SCC-mix totally differs from that of traditional concrete, since in SCC the properties of fresh concrete have the priority over other properties. The complete procedures for mix design of SCC are explained in Fig. (2).

Tests and Procedures

Concrete mixes were designed, treated, and controlled under the same conditions. The following key tests which differentiate SCC from ordinary concrete were carried out on the fresh-SCC:

Slump Flow Test .. The conventional slump test was used to determine the consistency of fresh concrete. The free deformability of SCC is also determined by measuring the slump flow. This test measures the ability of SCC to flow into all the spaces within the formwork under its own weight. Slump flow is determined by measuring the mean of two orthogonal diameters of the concrete base following the removal of the slump cone as shown in Fig. (3) It is one of the most popular methods of evaluating the flowability of SCC, both in laboratory and construction sites due to its ease of operation. This requires that the mix should have a high deformability, without excessive plastic viscosity. However, slump-flow test can not evaluate concrete's passage through reinforcement bars.

V-Funnel Test .. This test has been proposed for measuring deformation rate of SCC. It is a simple mean of evaluating the ability of concrete to pass through spaces [Fig. (4)]. The facility of concrete to change its path and spread through a restricted area without blockage is

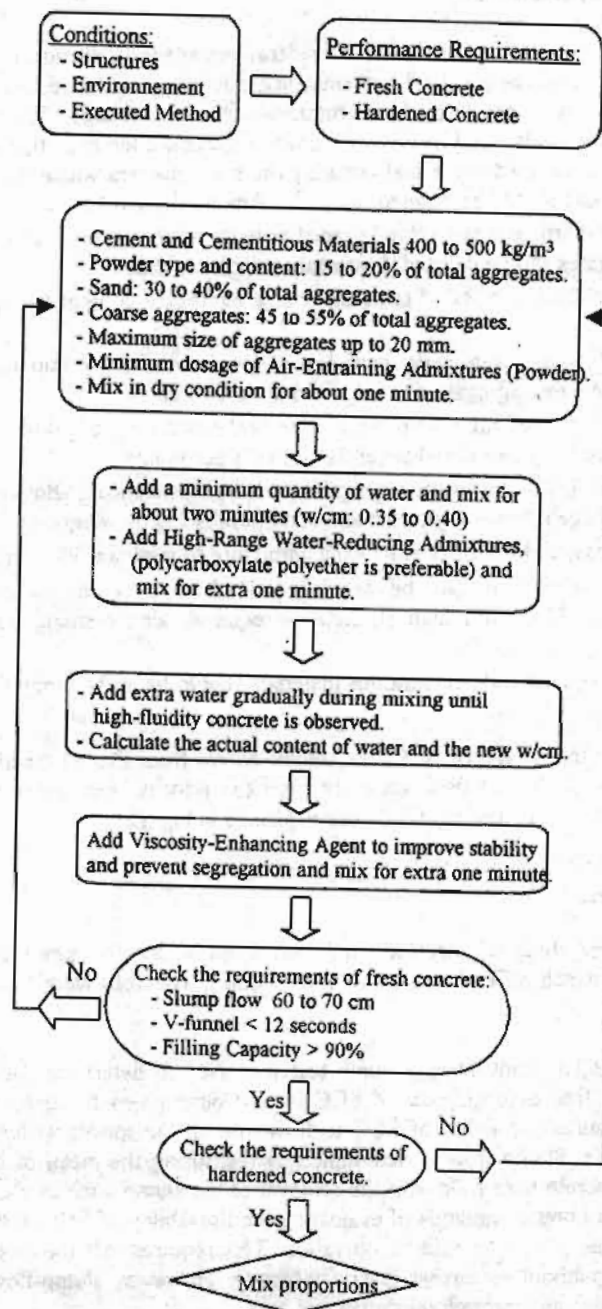

Fig. (2) Procedure for Mix Design of SCC.

measured by V-funnel test. After filling the funnel with concrete to its top edge, the outlet gate was opened and the time required for the concrete to flow out is measured. This time is defined as the time between the removal of the outlet gate and the time when the light becomes visible from the bottom.

Filling Capacity Test .. The filling-capacity box shown in Fig. (4), is used for assessing SCC for very heavily reinforced structures and difficult formwork shapes. This test evaluate self-compactability in terms of the concrete height after passing through parallel congested bars. The filling-capacity apparatus is a box with dimensions of 300 x 250 x 500 mm. A number of 35 closely-spaced-smooth horizontal bars are used to evaluate the filling capacity of the concrete through the restricted sections. The concrete is placed from the top of the unreinforced part with a constant rate. The concrete flows under its own weight among the closely spaced bars. This is continued until the concrete reaches a height of 250 mm in the unreinforced section. The filling capacity percentage is calculated as the ratio of $h \times 100 / 250$ where h is the height in mm of concrete at the end of reinforced part as shown in Fig. (4).

SCC was cast and placed in cube specimen under its own weight and without any vibration. For measuring the compressive strength of SCC, 150-mm cube specimens were made. All the test specimens were demolded after 24 hours and then submerged under water until tested (temperature: $20 \pm 2^\circ$). For each test, the average results of three specimens was determined.

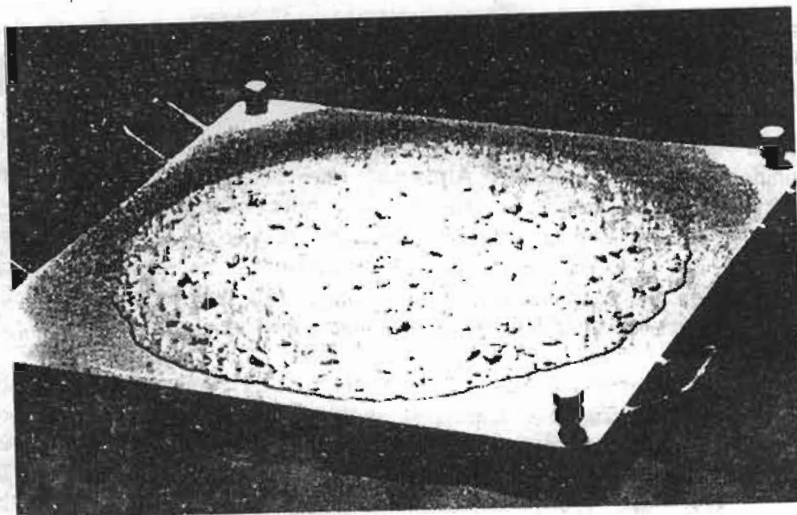

Fig. (3) Slump Flow of SCC.

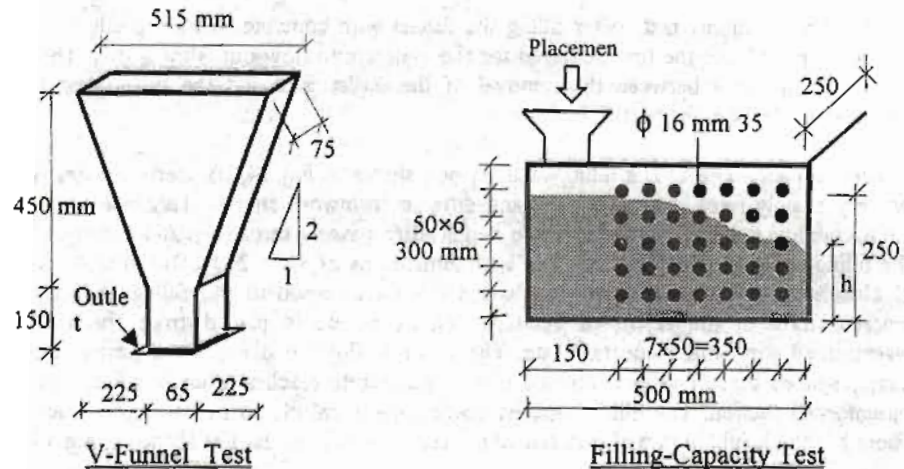

Fig. (4) Main Tests for Measuring the Properties of fresh-SCC.

WORKABILITY REQUIREMENTS OF SCC

For successful casting of SCC, it is necessary to ensure good balance between excellent deformability, stability, and preventing the blockage of concrete flow. Basic workability requirements of SCC are summarized in Fig. (5). A brief explanation of these requirements are given in the following sections:

High Deformability

Deformability of concrete is defined as the ability of the concrete to undergo a change in its shape under its own weight, even in the vicinity of obstacles that can interfere with its flow. In order to secure an SCC that can flow readily around various obstacles and achieve good filling capacity, it is important to insure both high flowability and high resistance to segregation (moderate viscosity). The deformability of concrete increases with the incorporation of superplasticizer. Although water and superplasticizer improves the flowability of concrete, but water reduces the viscosity of concrete, while superplasticizer results in a limited drop in viscosity. Therefore, an increase in w/c can provide high deformability, but it can also reduce the cohesiveness of the paste and lead to segregation of fine and coarse aggregate particles, causing blockage of the flow. Hence, a balance is needed to increase the w/c to enhance deformability without a substantial reduction in cohesiveness.

Another important parameter that affect deformability is the interparticle friction between the various solids (coarse and fine aggregates and powder materials). The interparticle friction increases when the concrete spreads through restricted spacing because of the greater collision between the various solid. This friction increases the internal resistance to flow, thus limiting the deformability and speed of flow of the fresh concrete. However, the use of superplasticizer disperses cement grains and reduces interparticle friction. Superplasticizer enables the reduction in water content while maintaining the required level of flowability and viscosity. The interparticle friction can also be reduced by the use of well-graded cementitious materials and fillers. Meanwhile, the effect of such filler materials on the workability loss, and temperature rise should be taken into consideration.

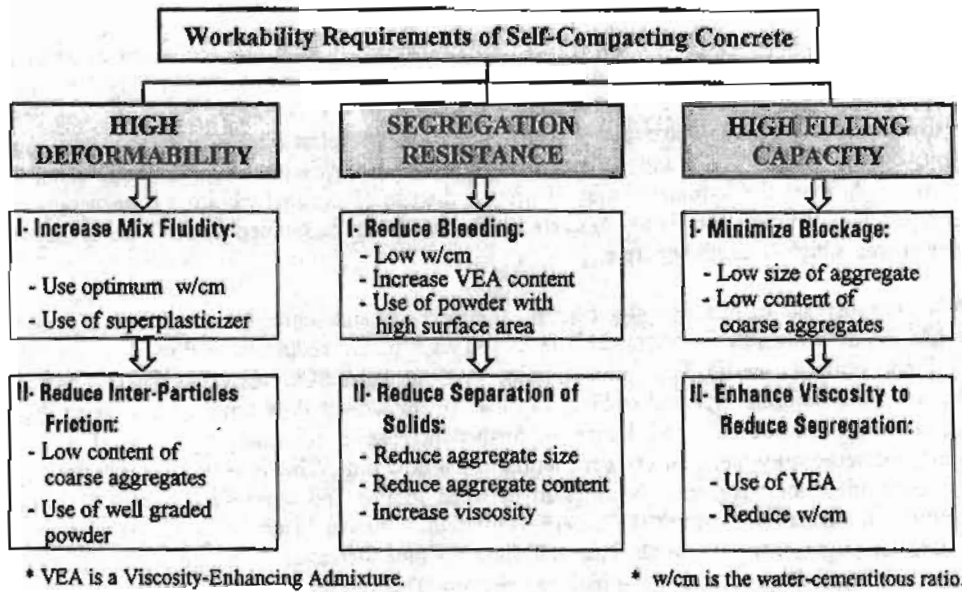

Fig. (5) Basic Workability Requirements of SCC.

Segregation Resistance

The second workability requirement necessary to provide SCC is the segregation resistance or the stability of the concrete. As shown in Fig. (5), improvement of segregation resistance involves the reduction in coarse aggregate content and the lowering of the maximum size of aggregate. It is also important to increase cohesion of the mix to enhance bond between the mortar and coarse aggregate, hence providing enough cohesion to insure uniform flow of both phases. Concrete with low cohesiveness can segregate since it can not maintain proper suspension of aggregate to insure uniform deformation around obstacles. As concrete deforms around a restricted section, a portion of the coarse aggregate can begin to segregate, which can result in an increase in aggregate density leading to coagulation and arching of the aggregate, and hence, blockage of the flow. Therefore, when concrete flows through restricted areas, such as between closely spaced reinforcement, it is important to insure that it has sufficient viscosity to maintain uniform suspension of solid particles. However, viscosity-enhancing admixture plays an important role in improving concrete stability and preventing segregation. It is also necessary to minimize bleeding of SCC.

High Filling Capacity

The third requirement essential to produce SCC is the high filling capacity of concrete or, in other words, minimizing the risk of blockage of concrete resulting from the flow in narrow spaces. To prevent blockage of concrete flow among closely spaced obstacles, concrete should have adequate cohesiveness by reducing the w/c and/or incorporating an adequate dosage of a viscosity-enhancing admixture. Compatibility is necessary between size of coarse aggregate particles and clear spacing of obstacles in congested section. In addition, well graded powder should be used to reduce inter-particle friction and minimize the risk of blockage.

Deformability - Stability Interaction

From the interrelation between workability properties presented in Fig. (6), three zones as I, II, and III may be distinguished. In the first zone, concrete exhibits high viscosity (i.e., high stability) with low deformability. This can happen when the concrete is proportioned with a low content of mixing water and a given dosage of superplasticizer. Concrete in this zone normally seems sticky, stiff and exhibits a very low slump flow with a high low time under its own weight from the V-funnel outlet. However, the use of external vibrators is necessary for compacting such concrete. Thus, concrete in zone I can not be defined as SCC, but it may be considered a high strength concrete.

With the increase of mixing-water content, the viscosity and segregation resistance decrease while the deformability increases. This results in an apparent reduction in flow time from the V-funnel outlet (zone II). The optimum point for a particular SCC-mix exists where a balance between the deformability and stability can lead to the lowest flow time. At this point, high quality SCC may be achieved. However, further increase in deformability (zone III, Fig. 6) does not necessarily mean an extra reduction in the flow time. This is because highly flowable concrete may not have enough cohesion between mortar and coarse aggregates to insure uniform deformation through the tapered outlet of V-funnel. Thus, a local coagulation of coarse aggregates may cause blockage and the flow time increases. Concrete in zone III has a low stability and aggregates suffer high segregation. This can lead to poor concrete with weak interface between the aggregate and cement paste. There will be a tendency to develop local microcracking that can increase permeability and reduce mechanical properties.

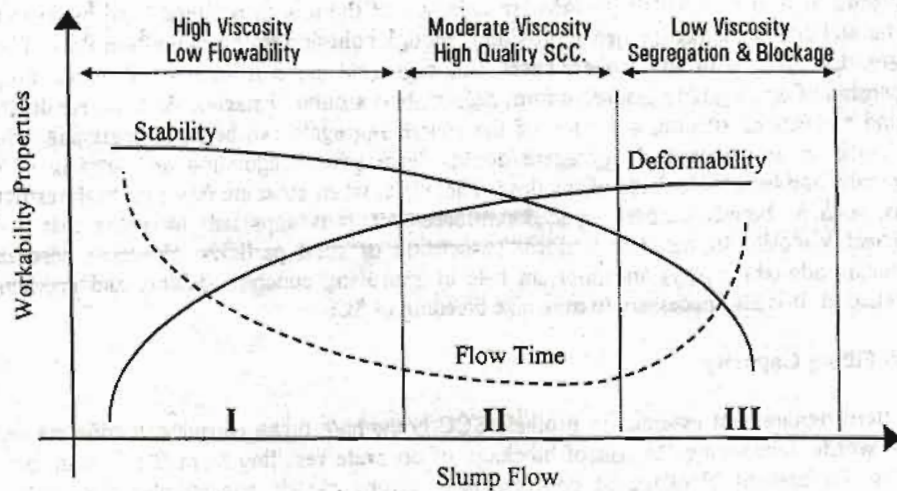

Fig. (6) Offhanded Interrelation Between Workability Properties of SCC.

Table 2 Test Results of Self-Compacting Concrete.

Property	Mix																	
	M1	M2	M3	M4	M5	M6	M7	M8	M9	M10	M11	M12	M13	M14	M15	M16	M17	M18
Slump -cm	23	26	26	27	26	26	27	28	27	27	27	25	27	27	28	27	27	27
Slump flow - cm	46	75	60	69	58	52	71	56	70	76	60	52	68	70	85	63	67	63
Filling capacity - %	B	40	66	88	72	84	100	74	78	98	80	86	90	91	100	90	91	88
Passing time - sec.	65	B	11	8	20	14	22	22	8	17	12	40	10	7	7	10	10	25
f_{c-28} - MPa	35	23.5	24.8	27.9	28.0	27.3	38.3	24.6	22.1	28.5	29.0	20.3	20.3	35.7	17.3	14.3	11.4	9.9

* B = Blockage

TEST RESULTS AND DISCUSSION

In SCC, unlike traditional concrete, a combination of a greater number of constituent materials are used. This is due to the large number of particular properties required in SCC such as deformability, segregation resistance, and passing ability or no blocking of concrete. Test results of fresh concrete properties are given in Table 2. The values obtained from these tests are quite appropriate for using SCC in any construction site. Fig. (7-a) shows the test results of slump flow of different SCC-mixes. An extensive literature review on the practice and application of SCC was made. There was a general consensus [2, 3, 5-8] that slump flow should be not less than 600 mm. Accordingly, mixes M1, M5, M6, M8, and M12 which revealed slump-flow values less than 600 mm, may be excluded from being successful SCC mixes. However, mix M15 exhibited a value of slump flow as high as 850 mm. On the other hand, the results of the filling capacity of different SCC mixes are shown in Fig. (7-b). It can be noted that mixes M1, M2, M3, M5, M6, M8, M9, and M11 yielded a filling capacity percent less than the recommended-minimum percentage (85%). In mix M1, a blockage of concrete in the filling-capacity box has occurred. This may be due to the high content of coarse aggregate in this mix (0.7 m^3) and the absence of any fine materials such as limestone powder or fine sand. Mixes M7, and M15 resulted in a filling capacity percent as high as 100%. Seven different mixes revealed filling capacity percentages greater than or equal 90%. These results may be considered quite appropriate for producing successful SCC.

Fig. (7-c) presents the results of passing time of different SCC mixes from V-funnel. For high quality SCC, the passing time should not be greater than 12 seconds [5-8]. The results indicated that, nine different mixes showed higher passing time, while other nine mixes gave good results for passing time (≤ 12 sec.). Mix M2 exhibited blockage of concrete in the outlet of V-funnel. This reflects the less ability of concrete in this mix to path through a restricted area. On the contrary, mixes M4, M9, M14, and M15 revealed high ability to spread through the outlet of V-funnel (7 to 8 sec). Thus, the three main properties of SCC are slump flow, filling capacity, and passing time. The results of these properties are integrally analyzed. It can be noted that, the results of mixes M1, and M8 are beyond the limitations of SCC. Other mixes such as M3, M7, M9, M10, M11, and M18 have succeeded to attain the recommended limits of two main properties, but have failed to pass the limits of the third property. Meanwhile, mixes M4, M13, M14, M15, M16, and M17 have successfully attained the recommended levels suggested for achieving high quality SCC.

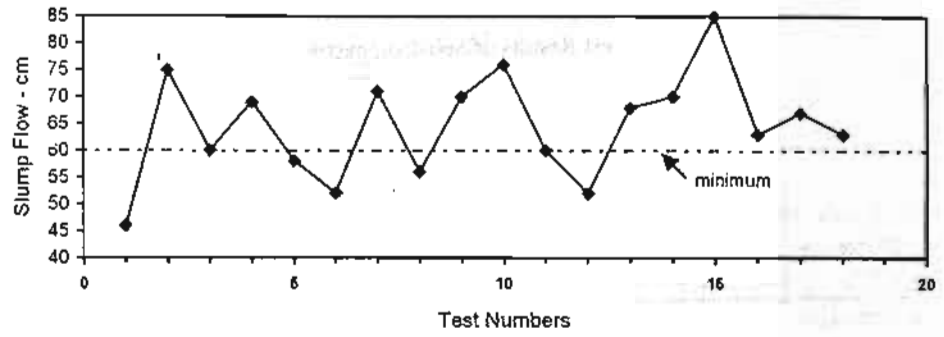

Fig. (7-a) Slump Flow of Different SCC-Mixes.

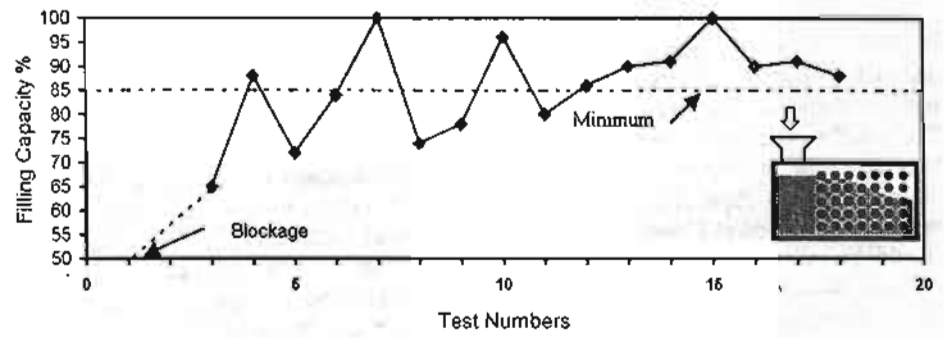

Fig. (7-b) Filling Capacity of Different SCC-Mixes.

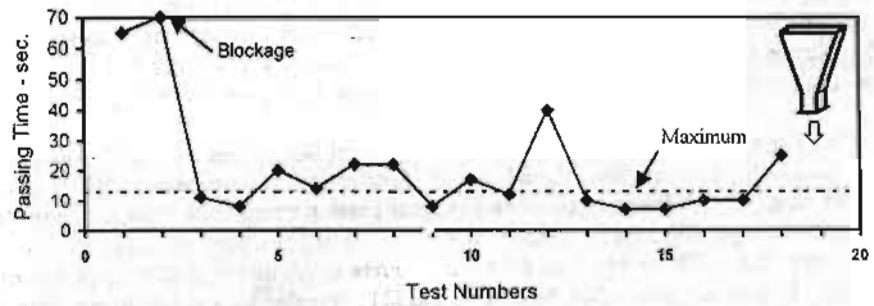

Fig. (7-c) Passing Time of Different SCC-Mixes.

Fig. (8) presents the effect of limestone powder fraction on the workability properties of SCC. The contents of limestone powder changed from 0 to 25% by weight of total aggregates. Sand with a content of 35% by weight of total aggregates is kept constant in all mixes, while gravel content was changed according to the change of limestone-powder content. Thus, the total content of both gravel plus limestone powder is always 65% by weight of total aggregates. Test results indicated that, the use of 15% of limestone powder (gravel = 50%) gave very good results of fresh concrete properties. The recorded filling capacity was 88%, slump flow was 690 mm, and passing time from V-funnel was 8 sec. All these results cover the desired-recommended values suggested for high quality SCC. It is worth noting that, blockage of concrete occurred for mixes containing limestone powder with content less than 10% by weight of total aggregates (M1, and M2). When limestone powder with content greater than 15% was incorporated, the flowability of SCC is getting lower. For example, mixes containing limestone powder with contents of 20, and 25% (M5, and M6) yielded slump flow of 580, and 520 mm respectively. Thus, it may be concluded that, the optimum content of limestone powder is about 15% by weight of total aggregates. For stable SCC-mixes with slump values greater than 250 mm, the slump measurement is not as sensitive as that of the slump flow or passing time value in reflecting small changes in the consistency of SCC as shown in Fig. (9-a, b). Within the limited number of mixes in this study (18 mixes), the slump values ranged from 230 to 280 mm with a coefficient of variation of only 4.15%. The corresponding range for slump-flow results was 460 to 850 mm with a variation coefficient of 15.13%, while the passing time ranged from 7 to 65 sec. with a coefficient of variation as high as 81.79%.

Although the attainment of the desired properties of fresh concrete is the most important goal in case of SCC, the compressive strength of hardened concrete still the main property that can not be ignored. The results of 28-days compressive strength of different SCC-mixes are given in Table 2. The compressive strength ranged from 9.9 to 36.3 MPa depending on the proportion of the constituent materials in each mix. It can be noted that, mix M7 which provided the highest compressive-strength value, passed through the outlet of V-funnel in time as high as 22 sec. It can also be noted that, mixes containing air-entraining admixtures (M15 to M18) exhibited compressive strength less than 20 MPa. However, mixes which successfully attained the recommended levels of the desired properties of fresh concrete, provided compressive strength in the range from 11.4 to 35.7 MPa. The compressive strength of mixes M14 and M4 are 35.7, and 27.9 MPa. These results emphasize the merit of using and utilizing such SCC mixes in structural purposes.

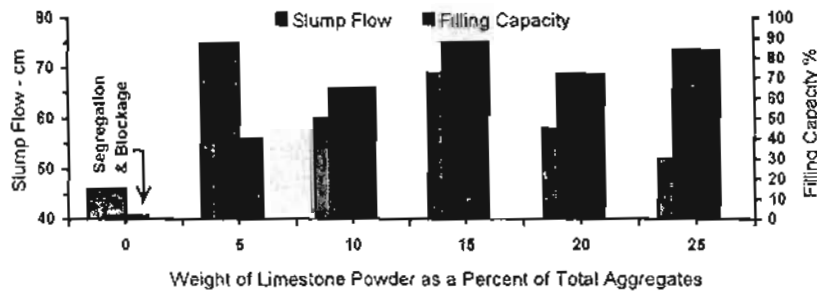

Fig. (8) Effect of Limestone-Powder Fraction on SCC.

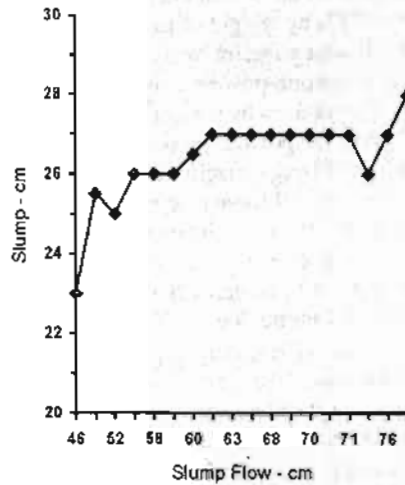

Fig. (9-a) Slump versus Slump-Flow.

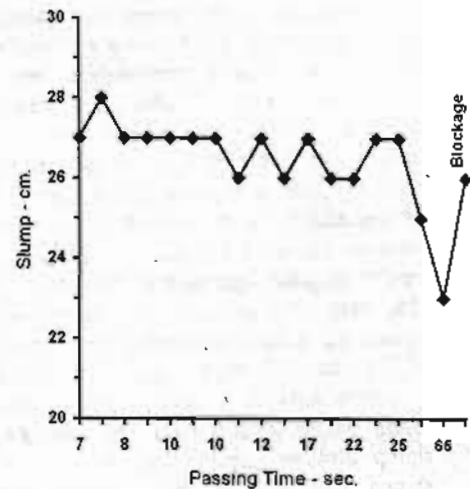

Fig. (9-b) Slump versus Passing-Time.

CONCLUSIONS

SCC has been successfully produced using available local materials. The proportioning and test results of eighteen different mixes were presented. SCC-mixes provided slump flow up to 850 mm, filling capacity up to 100%, passing time up to 7 sec., and compressive strength up to 36.3 MPa. SCC offers high deformability, stability, segregation resistance, and high filling capacity with good resistance to blockage upon flowing through congested areas. The findings of this research may be useful to engineers considering the use of SCC to facilitate the casting of congested areas with limited compaction effort or to repair damaged structural sections that present difficulties for concrete placement and consolidation. SCC is believed to be a promising construction material in the near future. Based on the results of the experimental work presented in this paper, the following guidelines are drawn:

- 1- Viscosity-Enhancing admixture together with the new generation superplasticizer based on a modified polycarboxylic-polyether may be considered the keystone for producing SCC.
- 2- Despite the higher degree of concrete wetness (w/c up to 0.61), the incorporation of viscosity-enhancing admixture with a dosage of 0.5 to 1.5% by weight of cement improved cohesion and provided more uniform flowable concrete.
- 3- The incorporation of limestone powder with a content of about 15% by weight of total aggregates (gravel = 50%, and sand = 35%) improved segregation resistance and the flowability of SCC. The recorded filling capacity was 88%, slump flow was 690 mm, and passing time from V-funnel was 8 sec.
- 4- The use of coarse aggregates with a maximum size not more than 20 mm and a content less than 55% by weight of total aggregates is necessary for producing SCC.
- 5- Although air-entraining admixture improved the desired properties of fresh concrete, it reversely affected the compressive strength of SCC. Thus, when SCC with high strength is required, air-entraining admixture is not advisable.
- 6- Three main tests which differentiate SCC from ordinary concrete were carried out and explained in this paper. These tests are slump-flow, V-funnel, and filling-capacity.

ACKNOWLEDGMENTS

The author is deeply indebted to the staff members of the laboratory of testing materials, Mansoura university, for their assistance during the conduct of the experimental part of this work. High appreciation and gratitude are due to the company of FOSROC for supplying materials to this research.

REFERENCES

- 1- M. Yurugi, N. Sakata, M. Iwai, and G. Sakai "Mix Proportions For Highly Workable Concrete" Proceedings of the International Conference, Concrete 2000, Edited by R. Dhir, and M. Jones, University of Dundee, Scotland, UK, Sept. 1993, pp. 579-589.
- 2- N. Nagamoto and K. Ozawa "Mixture Properties of Self-Compacting, High-Performance Concrete" American Concrete Institute, SP 172-33, edited by V. Malhotra, pp. 623-636.
- 3- H. Kim, Y. Park, Y. Song, C. Han, and S. Kang "Rheological Properties of Self-Compacting High-Performance Concrete" American Concrete Institute, SP 172-35, edited by V. Malhotra, pp. 653-668.
- 4- Proceedings of the first International RILEM Symposium on Self-Compacting Concrete, Stockholm, Sweden, 1999.
- 5- R. Khurana, and O. Topcu "Role of Superplasticizers in the Development of Self Compacting Concrete" Proceedings of the 2nd International Symposium on Cement and Concrete Technology in the 2000s, Sept. 2000, Istanbul, Turkey, pp. 473-482.
- 6- O. Topcu, A. Saglik, I. Cil, M. Inal, S. Polat, A. Uste, "Applications of Self-Compacting Concrete in Common Building Structure - A Case Study." Proceedings of the 2nd International Symposium on Cement and Concrete Technology in the 2000s, Sept. 2000, Istanbul, Turkey, pp. 483-492.
- 7- M. Hulusi, U. Dogan, Z. Cavdar, A. Saglam, and N. Parlak "Effects of Self-Compacting Concrete Admixtures on Fresh and Hardened Concrete Properties" Proceedings of the 2nd International Symposium on Cement and Concrete Technology in the 2000s, Sept. 2000, Istanbul, Turkey, pp. 493-502.
- 8- K. Khayat "Workability, Testing, and Performance of Self-Consolidating Concrete" ACI Materials Journal, V. 96, No. 3, May-June 1999, pp. 346-353.
- 9- K. Khayat "Optimization and Performance of Air-Entrained, Self-Consolidating Concrete" ACI Materials Journal, V. 97, No. 5, September-October 2000, pp. 526-535.
- 10- K. Khayat "Frost Durability of Concrete Containing Viscosity-Modifying Admixtures" ACI Materials Journal, V. 92, No. 6, November-December 1995, pp. 625-633.
- 11- K. Khayat, K. Manai, and A. Trudel "In Situ Mechanical Properties of Wall Elements Cast using Self-Consolidating Concrete" ACI Materials Journal, V. 94, No. 6, November-December 1997, pp. 491-500.
- 12- K. Khayat, and Z. Guizani "Use of Viscosity-Modifying Admixtures to Enhance Stability of Fluid Concrete" ACI Materials Journal, V. 94, No. 4, July-August 1997, pp. 332-340.
- 13- J. Kim, and S. Han "Mechanical Properties of Self-Flowing Concrete" American Concrete Institute, SP 172-34, edited by V. Malhotra, pp. 637-652.
- 14- N. Miura, N. Takeda, R. Chikamatsu, and S. Sogo "Application of Super Workable Concrete to Reinforced Concrete Structures with Difficult Construction Conditions" American Concrete Institute, SP 140-8, edited by Paul Zia, pp. 163-186

- 15- K. Kato, S. Yang, and M. Kunishima "A Comparative Study on The Constructability of Self-Placeable Concrete" Proceedings of the International Conference, Concrete 2000, Edited by R. Dhir, and M. Jones, University of Dundee, Scotland, UK, Sept. 1993, pp. 881-890.
- 16- J. Sakamoto, Y. Matsuoka, and S. Tangtermsirikul "Application of Super-Workable Concrete To Actual Construction" Proceedings of the International Conference, Concrete 2000, Edited by R. Dhir, and M. Jones, University of Dundee, Scotland, UK, Sept. 1993, pp. 891-902.
- 17- H. Takeuchi, M. Higuchi, and A. Nanni "Applications of Flowable Concrete in a Tunnel Lining" Concrete International, April 1994, pp. 26-29.
- 18- J., Michael, and J., Philippe, "Self-Compacting Concrete - Expanding the Possibilities of Concrete Design and Placement" Concrete International, April 2000, pp. 31-34.
