

Evaluation Study on Speed Control of dc Series Motor Supplied by Photovoltaic System via Bacterial Foraging

A. S. Oshaba¹ and E. S. Ali²

¹Electronics Research Institute, Power Electronics and Energy Conversions,

NRC Bldg., El-Tahrir St., Dokki, 12311-Giza, Egypt, Email: oshaba68@hotmail.com

²Electric Power and Machine Department, Faculty of Engineering, Zagazig University, Egypt, Email: ehabsalimalisalama@yahoo.com

Abstract

This paper presents the design and evaluation of a speed control scheme for a DC series motor supplied by Photovoltaic (PV) system. The proposed design problem of speed controller is formulated as an optimization problem. Bacteria Foraging Optimization Algorithm (BFOA) is employed to search for optimal controller parameters by minimizing the time domain objective function. The performance of the proposed technique has been evaluated with respect to load torque variation, ambient temperature and radiation. Simulation results have shown the validity of the proposed technique in controlling the speed of DC series motor under different disturbances.

يقدم هذا البحث التحكم في محرك تيار مستمر نوالى باستخدام الطاقة الشمسية حيث تم صياغة التصميم واستخدام خوارزم الامثلية البكتيرية الهندسة للحصول على متغيرات الحاكم وذلك بواسطة الحصول على اقل قيمة . وتم اختبار النظام المقترح عند تعرض المحرك لاضطراب فى الحمل وتظهر النتائج النظرية قدرة نظام التحكم على التحكم فى سرعة المحرك عندما يتعرض لانواع مختلفة من الاضطرابات

Keywords: DC Series Motor, Photovoltaic System, Speed Control, PI Controller, Bacteria Foraging Optimization Algorithm.

1 Introduction

DC series motors are widely used in traction and application that required high starting torque [1-2]. Due to the inherent characteristic possessed by the DC motor system, such as the complexity of the nonlinear system, unavailability of an accurate and precise mathematical model, the use of conventional PI controller become a suitable solution due to small steady-state error and low costs. However, searching the parameters of PI controller is not an easy task, particularly under varying load conditions, parameter changes and abnormal modes of operation [3-4]. Hence, a novel optimization technique called Bacteria Foraging Optimization Algorithm (BFOA) is used to search for the optimal PI controller parameters for a DC series motor.

Photovoltaic (PV) system refers to an array of cells containing a solar photovoltaic material that converts solar radiation into direct current electricity. Solar PV systems work by converting light into electrical power. This is achieved using a thin layer of semi-conducting material, most commonly silicon, enclosed in a glass

or plastic casing. When exposed to sunlight the semi-conducting material causes electrons in the materials' atoms to be knocked loose. The electrons that are knocked loose then flow through the material to produce an electric current known as a DC. The DC is carried through wiring to an inverter which converts the current to AC so it can be connected to main electricity distribution board which either used within the home or fed back into the national grid [5-7]. PV is used in this paper to power DC series motor.

BFOA is a new optimization technique is developed to optimally tune the controller parameters [8]. Moreover, BFOA due to its unique dispersal and elimination technique can find favorable regions when the population involved is small. These unique features of the algorithms overcome the premature convergence problem and enhance the search capability. Hence, it is suitable optimization tool for power system controllers [8-12].

This paper proposes a new optimization algorithm known as BFOA for speed control of DC series motor supplied by PV system. BFOA is used for tuning the

PI controller parameters to control the duty cycle of DC/ DC converter and therefore speed control of DC series motor. The design problem of the proposed controller is formulated as an optimization problem and BFOA is employed to search for optimal controller parameters. By minimizing the time domain objective function representing the error between reference speed and actual one is optimized. Simulation results assure the effectiveness of the proposed controller in providing good speed tracking system over a wide range of load torque, ambient temperature and radiation with minimum overshoot and steady state error.

2 System Under study

The system under study consists of PV system acts as a voltage source for a connected DC series motor. The proposed controller based on BFOA is used to control the speed of DC series motor. The schematic block diagram is shown in Fig. 1.

2.1 DC Series Motor Construction

The DC series motor is a varying speed machine with a markedly drooping speed torque characteristic of the type. For applications requiring heavy torque overloads, this characteristic is particularly advantageous because the corresponding power overloads are held to more reasonable values by the associated speed drops. Very favorable starting characteristics also result from the increase in flux with increased armature current [13-18]. The parameters of DC series motor are shown in appendix.

The proposed system can be simulated with proper mathematic modeling. The DC series motor can be written in terms of equations as follows [13-17].

$$\frac{di_a(t)}{dt} = \frac{V_t(t)}{L_a + L_f} - \frac{R_a + R_f}{L_a + L_f} i_a(t) - \frac{M_{af}}{L_a + L_f} i_a(t) \omega_r(t) \quad (1)$$

$$\frac{d\omega_r(t)}{dt} = \frac{M_{af}}{J_m} i_a^2(t) - \frac{f}{J_m} \omega_r(t) - \frac{T_L}{J_m} \quad (2)$$

Where

- i_a = The armature current,
- V_t = The motor terminal voltage,
- R_a, L_a = The armature resistance and inductance,
- R_f, L_f = The field resistance and inductance,
- ω_r = The motor angular speed,
- J_m = The moment of inertia,
- T_L = The load torque,
- f = The friction coefficient,
- M_{af} = The mutual inductance between the armature and field.

2.2 Photovoltaic Modeling

Solar cell mathematical modeling is an important step in the analysis and design of PV control systems. The PV mathematical model can be obtained by applying the fundamental physical laws governing the nature of the components making the system [5].

To overcome the variations of illumination, temperature, and load resistance, voltage controller is

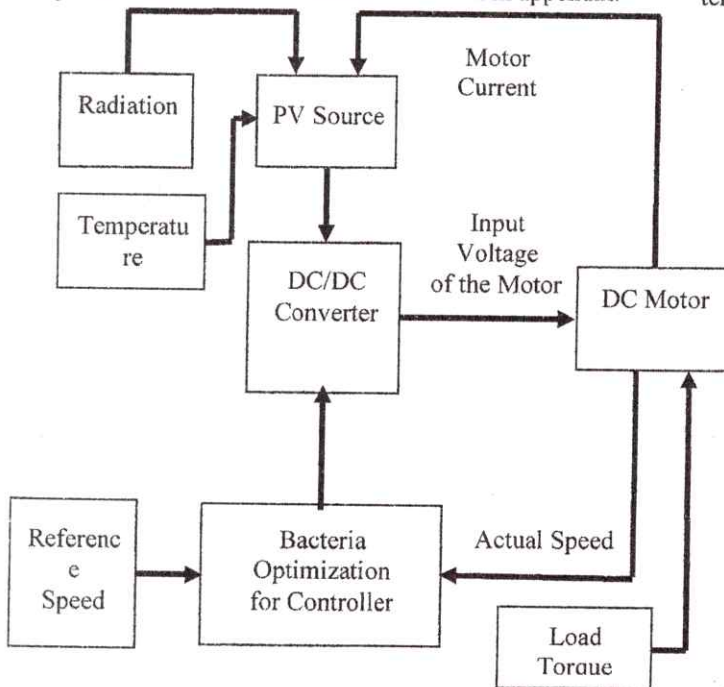

Fig. 1. Overall block diagram of DC series motor for control system.

required to track the new modified reference voltage whenever load resistance, illumination and temperature variation occurs. I-V characteristics of solar cell are given by the following equations [6-7]:

The solar cell mathematical modeling is:

$$I_c = I_{ph} - I_o \left\{ e^{\left[\frac{q}{AKT} (V_c + I_c R_s) \right]} - 1 \right\} \quad (3)$$

Using equation (1) the cell voltage can be stated as

$$V_c = \frac{AKT}{q} \ln \left(\frac{I_{ph} + I_o - I_c}{I_o} \right) - I_c R_s \quad (4)$$

The photoelectric current and reverse saturation current of the solar cell can be calculated, respectively, using the following formulas

$$I_{ph} = \frac{G}{1000} [I_{sc} + k_i (T - T_r)] \quad (5)$$

$$I_o = I_{or} \left(\frac{T}{T_r} \right)^3 e^{\left[\frac{qE_g}{AK} \left(\frac{1}{T_r} - \frac{1}{T} \right) \right]} \quad (6)$$

The photovoltaic module consists of series connected solar cells (n_s), therefore, the current-voltage (I-V) characteristics of the whole module can be derived by

$$I = I_{ph} - I_o \left\{ e^{\left[\frac{q}{n_s AKT} (V + n_s I R_s) \right]} - 1 \right\} \quad (7)$$

$$V = \frac{n_s AKT}{q} \ln \left(\frac{I_{ph} + I_o - I}{I_o} \right) - n_s I R_s \quad (8)$$

The module output power can be determined simply from

$$P = V.I \quad (9)$$

Where;

- I and V; = are cell output current and voltage,
- I_s = cell reverse saturation current,
- T = cell temperature,
- K = Boltzmann's constant,
- q = electronic charge,
- KT = (0.0017 A/°C) short circuit current temperature coefficient,
- G = solar illumination in W/m²,
- E_g = band gap energy for silicon,
- A = ideality factor,
- T_r = reference temperature,
- I_{or} = cell rating saturation current at T_r .

Thus, if the module parameters such as module series resistance (R_s), reverse saturation current (I_o), and ideality factor (A) are known, the I-V characteristics of the PV module can be simulated by using equations (7 and 8). The Matlab/Simulink of overall system can be simulated as shown in Fig. 2.

2.3 DC-DC Converter

The choice DC-DC converter technology has a significant impact on both efficiency and effectiveness. Many converters have been used and tested; buck converter is a step down converter, while boost converter is a step up converter [15]. In this paper, a hybrid (buck and boost) DC/DC converter is used. The equations for this converter type in continuous conduction mode are:

$$V_B = \frac{-K}{1-K} V_{ph} \quad (10)$$

$$i_B = \frac{K-1}{K} i_{ph} \quad (11)$$

where K is the duty cycle of the pulse width modulation (PWM) switching signal this gain is the controller output gain .

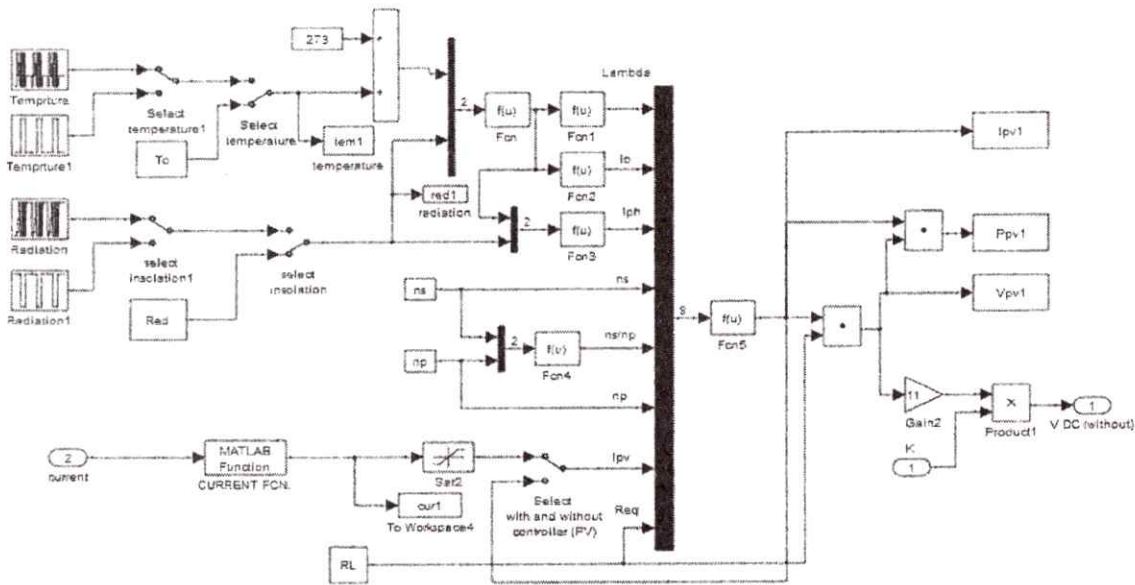

3. Objective Function

A performance index can be defined by the Integral of Time multiply Absolute Error (ITAE). Accordingly, the objective function J [12] is set to be:

$$J = \int_0^{\infty} t(|e|)dt \tag{12}$$

Where $e = w_{reference} - w_{actual}$

Based on this objective function J optimization problem can be stated as: Minimize J subjected to:

$$K_p^{min} \leq K_p \leq K_p^{max}, \quad K_i^{min} \leq K_i \leq K_i^{max} \tag{13}$$

This study focuses on optimal tuning of PI controller for speed tracking of DC motor using BFOA algorithm. The aim of the optimization is to search for the optimum controller parameters setting that minimize the difference between reference speed and actual one. On the other hand, in this study the goal is speed control of DC motor and finally designing a low order controller for easy implementation.

4. Overview of BFOA

Natural selection tends to eliminate animals with poor foraging strategies and favor the propagation of genes of those animals that have successful foraging strategies since

they are more likely to enjoy reproductive success. After many generations, poor foraging strategies are either eliminated or shaped into good ones. The Escherichia colibacteria that are present in human intestine also undergo a foraging strategy. The control system of these bacteria that dictates how foraging should proceed can be subdivided into four sections namely Chemotaxis, Swarming, Reproduction and Elimination and Dispersal [8-10].

A. Chemotaxis

The characteristics of movement of bacteria in search of food can be defined in two ways, i.e. swimming and tumbling together known as chemotaxis. A bacterium is said to be ‘swimming’ if it moves in a predefined direction, and ‘tumbling’ if moving in an altogether different direction. Mathematically, tumble of any bacterium can be represented by a unit length of random direction $\phi(j)$ multiplied by step length of that bacterium $C(i)$. In case of swimming, this random length is predefined.

B. Swarming

For the bacteria to reach at the richest food location, it is desired that the optimum bacterium till a point of time in the search period should try to attract other bacteria so that together they converge at the desired location more rapidly. To achieve this, a penalty function based upon the relative distances of each bacterium from the fittest bacterium till that search duration, is added to the original cost function. Finally, when all the bacteria have merged into the solution point, this penalty function becomes zero. The effect of

swarming is to make the bacteria congregate into groups and move as concentric patterns with high bacterial density.

C. Reproduction

The original set of bacteria, after getting evolved through several chemotactic stages reaches the reproduction stage. Here, best set of bacteria gets divided into two groups. The healthier half replaces with the other half of bacteria, which gets eliminated, owing to their poorer foraging abilities. This makes the population of bacteria constant in the evolution process.

D. Elimination and Dispersal

In the evolution process, a sudden unforeseen event can occur, which may drastically alter the smooth process of evolution and cause the elimination of the set of bacteria and/or disperse them to a new environment. Most ironically, instead of disturbing the usual chemotactic growth of the set of bacteria, this unknown event may place a newer set of bacteria nearer to the food location. From a broad perspective, elimination, and dispersal are parts of the population level long distance motile behavior. In its application to optimization, it helps in reducing the behavior of *stagnation* often seen in such parallel search algorithms. The detailed mathematical derivations as well as theoretical aspect of this new concept are presented in [11-12]. The computational flow chart of BFOA algorithm is shown in Fig. 3. The parameters of BFOA are shown in appendix.

The algorithm of this technique involves two steps.

[Step 1] Initialization

- i) p is the number of parameters to be optimized.
- ii) S is the number of bacteria to be used for searching the total region.
- iii) N_S is the swimming length after which tumbling of bacteria will be undertaken in a chemotactic loop.
- iv) N_C is the number of iteration to be undertaken in a chemotactic loop ($N_C > N_S$).
- v) N_{re} is the maximum number of reproduction to be undertaken.
- vi) N_{ed} is the maximum number of elimination and dispersal events to be imposed over the bacteria.
- vii) P_{ed} is the probability with which the elimination and dispersal will continue.
- viii) P (1-p, 1-S, 1) is the location of each bacterium which is specified by random numbers on [-1, 1].
- ix) The value of $C(i)$ which is assumed to be constant in this case for all the bacteria to simplify the design strategy.
- x) The values of $d_{attract}$, $\omega_{attract}$, $h_{repellent}$ and $\omega_{repellent}$.

Step-2 Iterative algorithm for optimization

This section models the bacterial population chemotaxis, swarming, reproduction, elimination and dispersal (initially, $j=k=l=0$). For the algorithm updating θ^i automatically results in updating of P .

[1] Elimination-dispersal loop: $l=l+1$

[2] Reproduction loop: $k=k+1$

[3] Chemotaxis loop: $j=j+1$

a) For $i=1, 2, \dots, S$, calculate cost function value for each bacterium as follows.

- Compute value of cost function $J(i, j, k, l)$.

Let

$J_{sw}(i, j, k, l) = J(i, j, k, l) + J_{cc}(\theta^i(j, k, l), P(j, k, l))$ J_{cc} is defined by the following equation

$$J_{cc}(\theta, P(j, k, l)) = \sum_{i=1}^S J_{cc}(\theta, \theta^i(j, k, i))$$

$$= \sum_{i=1}^S \left[-d_{attract} \exp \left(-\omega_{attract} \sum_{m=1}^p (\theta_m - \theta_m^i)^2 \right) \right]$$

$$+ \sum_{i=1}^S \left[h_{repellent} \exp \left(-\omega_{repellent} \sum_{m=1}^p (\theta_m - \theta_m^i)^2 \right) \right]$$

(14)

- Let $J_{last} = J_{sw}(i, j, k, l)$ to save this value since one may find a better cost via a run.
 - End of For loop
- b) For $i=1, 2, \dots, S$ take the tumbling/swimming decision

- Tumble: generate a random vector $\Delta(i) \in \mathcal{R}^p$ with each element $\Delta_m(i)$ $m=1, 2, \dots, p$.
- Move:

$$\theta^i(j+1, k, l) = \theta^i(j, k, l) + C(i) \frac{\Delta(i)}{\sqrt{\Delta^T(i)\Delta(i)}}$$

Fixed step size in the direction of tumble for bacterium i is considered.

Compute $J(i, j+1, k, l)$ and

$$J_{sw}(i, j+1, k, l) = J(i, j+1, k, l) + J_{cc}(\theta^i(j+1, k, l), P(j+1, k, l))$$

Swim

i) Let $m=0$ (counter for swim length).

ii) While $m < N_S$ (have not climbed down too long)

- Let $m=m+1$
- If $J_{sw}(i, j+1, k, l) < J_{last}$ (if doing better), let $J_{last} = J_{sw}(i, j+1, k, l)$ and let

$$\theta^i(j+1, k, l) = \theta^i(j, k, l) + C(i) \frac{\Delta(i)}{\sqrt{\Delta^T(i)\Delta(i)}} \text{ and}$$

use this $\theta^i(j+1, k, l)$ to compute the new $J(i, j+1, k, l)$

- Else, let $m = N_s$. This is the end of the while statement.

iii) Go to next bacterium ($i+1$) if $i \neq S$

[4] If $j < N_c$, go to [step 3]. In this case, continue chemotaxis, since the life of the bacteria is not over.

[5] Reproduction

- For the given k and l , and for each $i=1,2, \dots, S$, let

$$J_{health}^i = \min_{j \in \{1 \dots N_c\}} \{J_{sw}(i, j, k, l)\}$$

be the health

of the bacterium i (a measure of how many nutrients it got over its life time and how successful it was at avoiding noxious substance). Sort bacteria in order of ascending cost J_{health} .

- The $S_r = S/2$ bacteria with highest J_{health} values die and other S_r bacteria with the best value split.

ii) [6] If $k < N_{re}$, go to [step 2]. In this case, one has not reached the number of specified reproduction steps, so one starts the next generation in the chemotactic loop.

iii) [7] Elimination-dispersal: for $i = 1, 2, \dots, N$, with probability P_{ed} , eliminate and disperse each bacterium, and this result in keeping the number of bacteria in the population constant. To do these, if you eliminate a bacterium, simply disperse one to a random location on the optimization domain. If $l < N_{ed}$, then go to [step 2]; otherwise end.

iv) The detailed mathematical derivations as well as theoretical aspect of this new concept were presented [9-10].

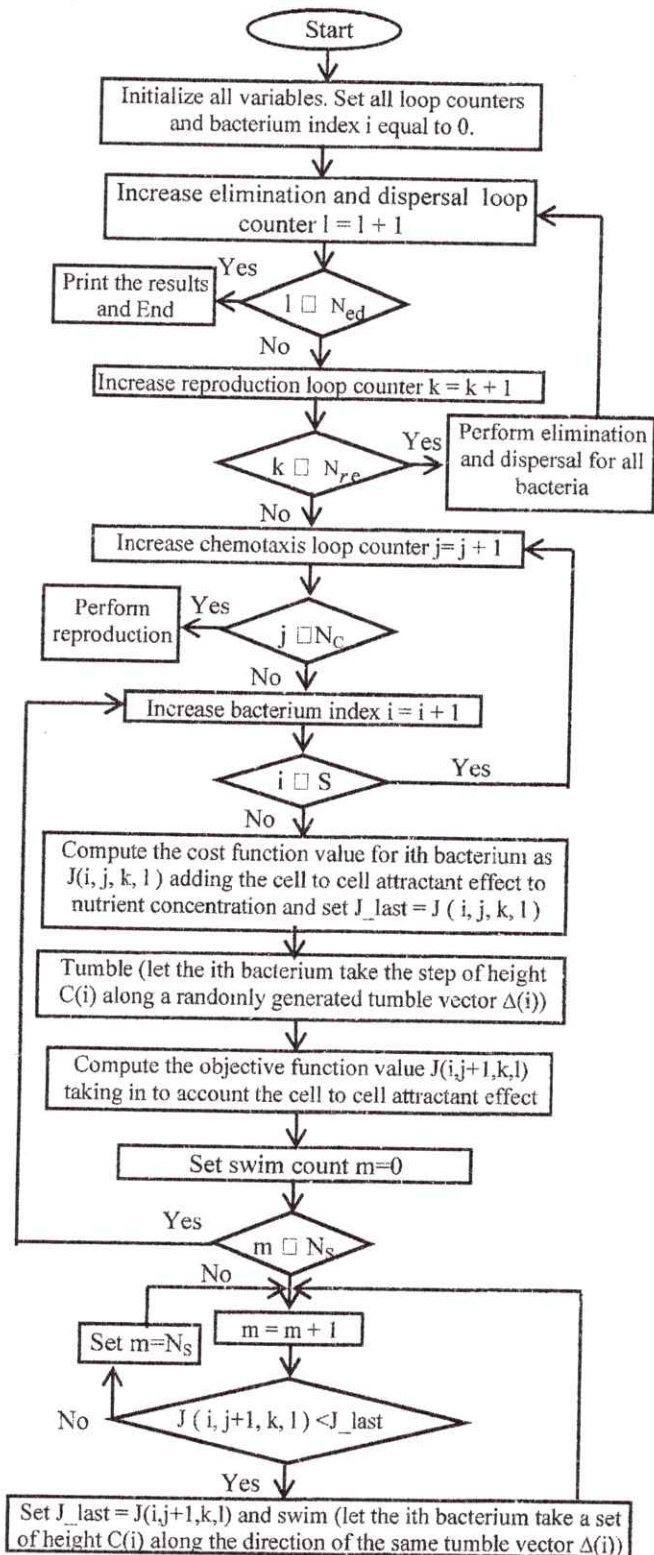

Fig. 3. Flow chart of BFOA.

5. Results and Discussion

In this section different comparative cases are examined to show the effectiveness of the proposed BFOA controller for load torque, ambient temperature and radiation variations.

5.1 Response under step change for load torque

Figs. 4-5 show the step change of load torque, the current, voltage and power of PV system. The motor current, control signal and speed response under variation of the load torque are shown in Figs. 6-7 respectively. The actual speed tracks the reference speed with minimum overshoot and settling time. The settling time is approximately 0.03 second. Moreover, the speed response is very fast for the step variation of load torque. The parameters of proposed PI controller are $K_p = 0.0959$, $K_i = 2.2626$.

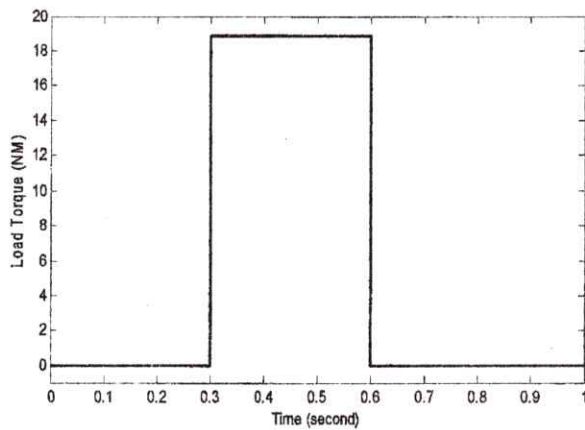

Fig. 4. Step change for load torque.

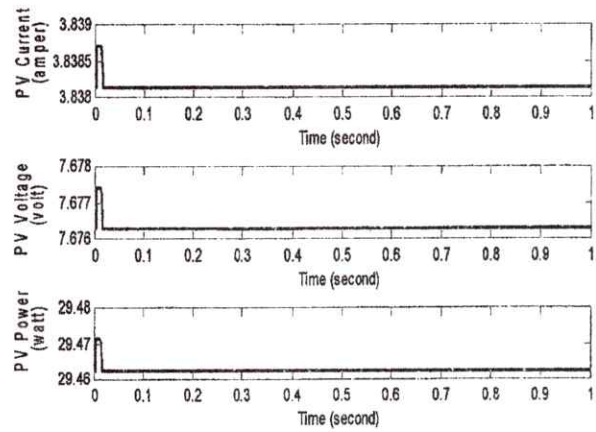

Fig. 5. The PV current, voltage and power

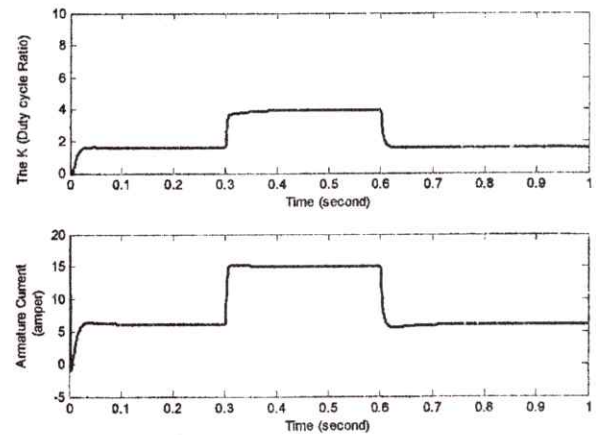

Fig. 6. The control signal and armature current

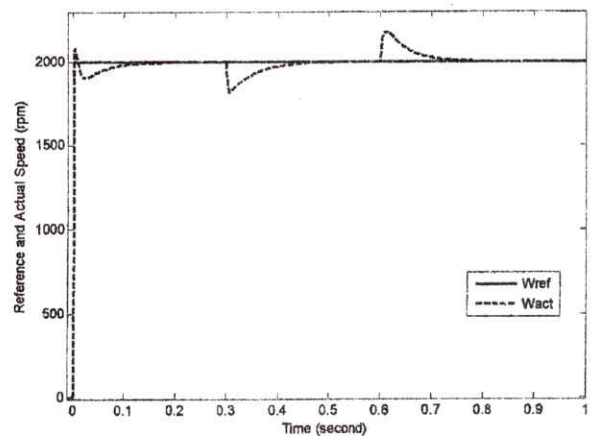

Fig. 7. The reference and actual speed for the DC series motor.

5.2 Response under step change of radiation

In this case, the system responses under variation of PV system radiation are obtained. Figs.8-9 show the variation of the PV system radiation as an input disturbance and the

control signal, motor current, current, voltage and power of PV system respectively. Moreover, the system responses based on BFOA are shown in Figs. 10 and 11. It is clear from these Figs., the proposed BFOA controller improves the speed control and the current response of DC series motor effectively. Also, the overshoot and settling time are highly minimized. Hence, PI based BFOA enhances the performance characteristics of DC series motor.

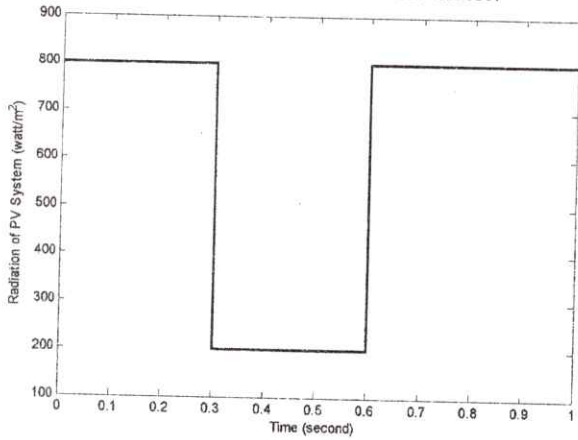

Fig. 8. Step change for PV system radiation.

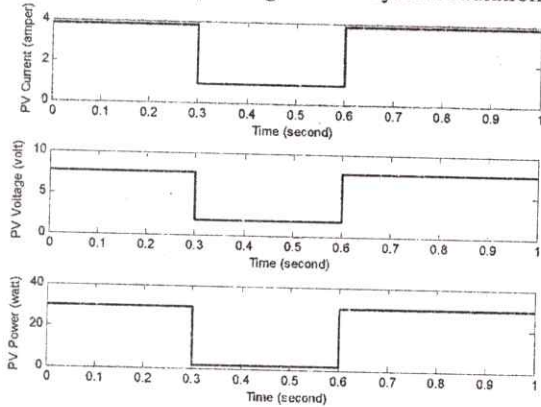

Fig. 9. The PV current, voltage and power

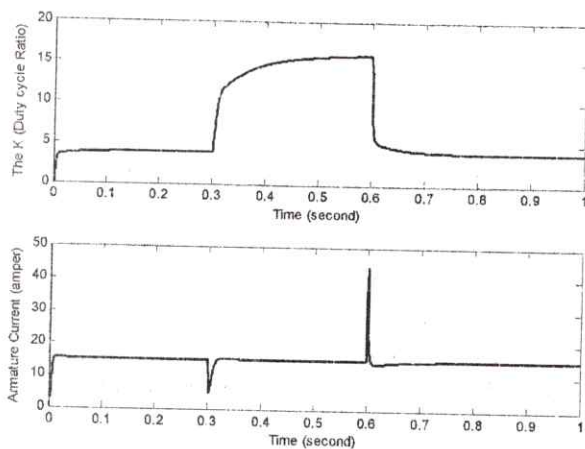

Fig. 10. The control signal and motor current

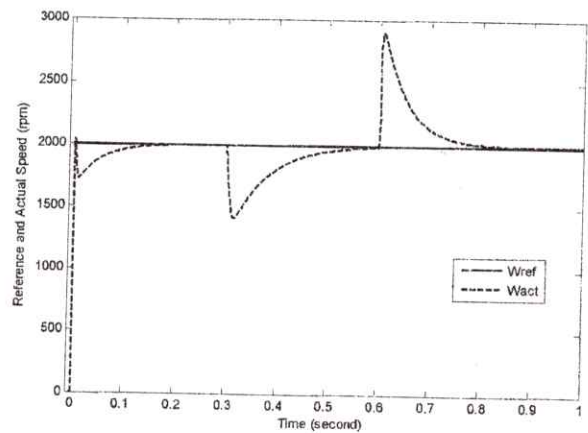

Fig. 11. The reference and actual speed for the DC series motor.

5.3 Response under step change of load torque, radiation and temperature

The effect of applying step change of load torque, radiation and temperature of PV system. Figs. 12-13 illustrate the variation of load torque, radiation, temperature and the output of PV system. The control signal, motor current and a comparison between the actual and reference speed are shown in Figs. 14-15 respectively. From these figures, the steady state and dynamic operation of DC series motor in terms of over shoot and settling time has been enhanced. Also, the actual speed tracks the reference speed at every step. Moreover, the proposed BFOA controller is effectively improved the speed control of DC series motor.

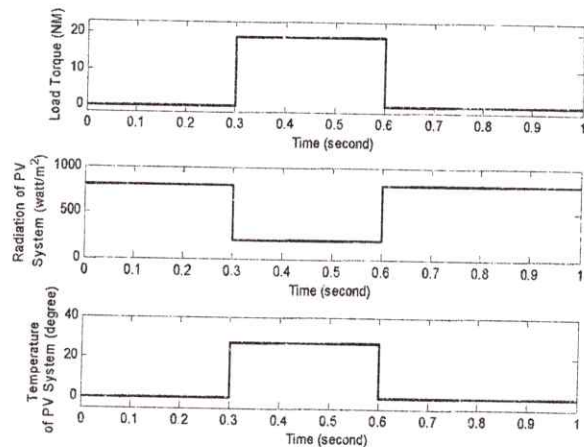

Fig. 12. Step change for load torque, PV system radiation and PV system temperature

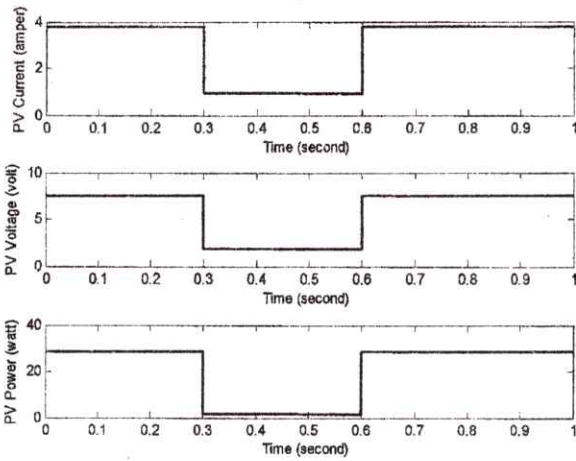

Fig. 13. The PV current, voltage and power.

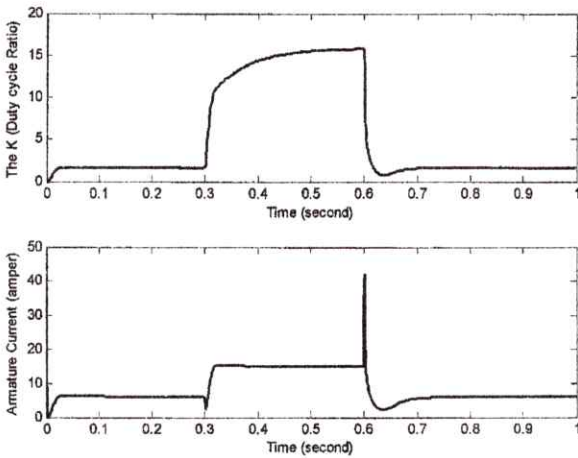

Fig. 14. The control signal and motor current

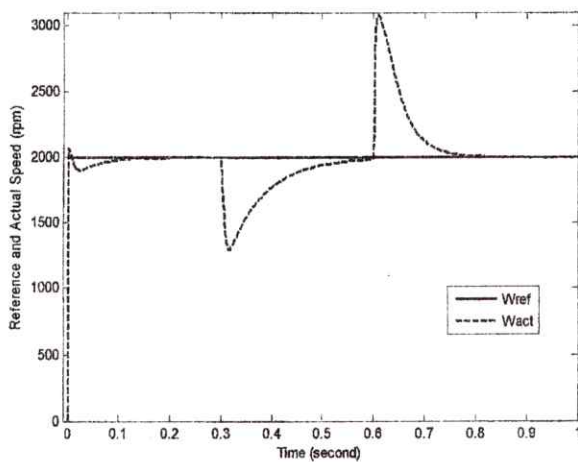

Fig. 15. The reference and actual speed for the motor.

5.4 Response under variables change of load torque, radiation and temperature

In this case, the system response under variations of load torque, radiation and temperature is obtained. Figs. 16-17 show the change of load torque, radiation, temperature and parameters of PV system respectively. Moreover, the effect of the proposed BFOA controller on speed response is illustrated in Fig. 18. It is clear from this Fig, that the proposed BFOA controller is robust in tracking every change of reference speed. Also, the proposed controller has a small settling time and system response is quickly driven with the reference speed. Hence, the potential and superiority of the proposed BFOA controller is demonstrated.

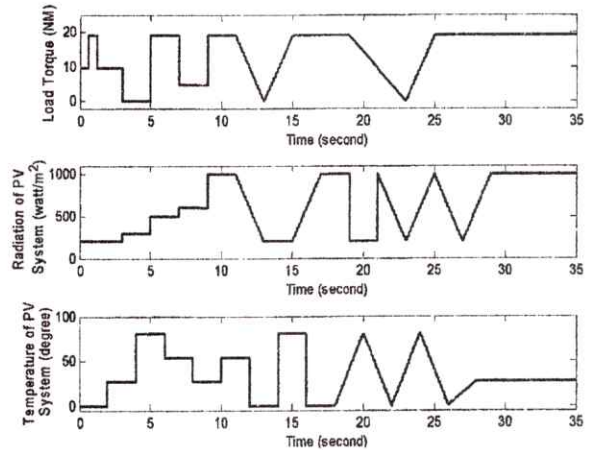

Fig. 16. The high disturbance for load torque, PV radiation and PV system temperature

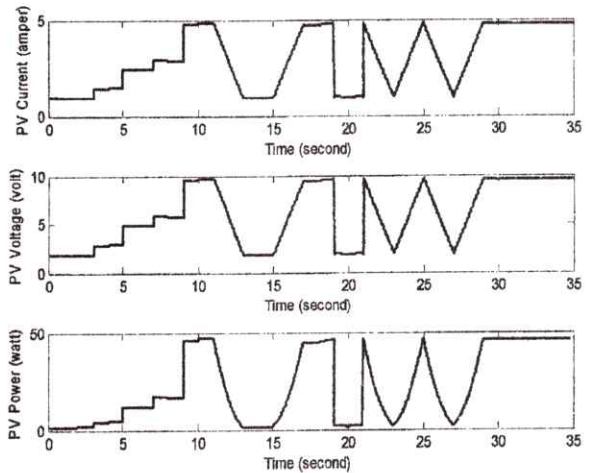

Fig. 17. The PV current, voltage and power

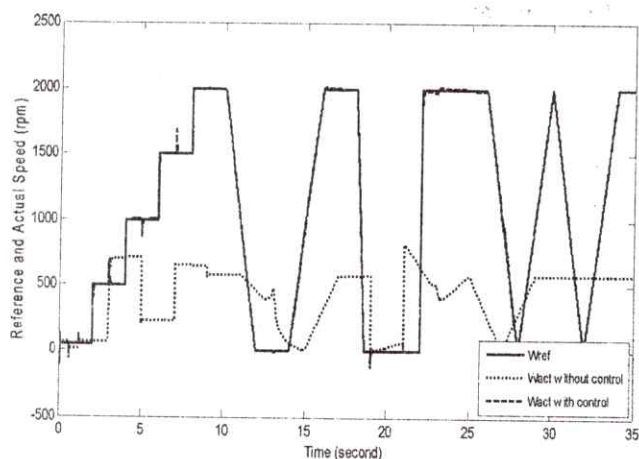

Fig. 18. The reference and actual speed for the motor With and without controller

6. Conclusions

A novel method of speed controller of DC series motor was designed using the BFOA algorithm. The design problem of the proposed controllers is formulated as an optimization problem and BFOA is employed to search for optimal parameters of PI controller. By minimizing the time domain objective function, in which the difference between the reference and actual speed are involved; speed control of DC series motor is improved. Simulation results emphasize that the designed BFOA tuning PI controller is robust in its operation and gives a superb performance for the change in load torque, radiation, temperature. Besides the simple architecture of the proposed controller, it has the potentiality of implementation in real time environment.

7. References

- [1] G. K. Dubey, "Fundamentals of Electric Drives", Narosa Publishing House New Delhi, 1989.
- [2] M. H. Rashid, "Power Electronics Circuits Devices and Applications", Prentice Hall, 3rd edition, 2003.
- [3] P.T.Krein, "Elements of Power Electronics", Oxford University Press, 1998.
- [4] N.S. Kumar, V.Sadasivam, K.Prema, "Design and Simulation of Fuzzy Controller for Closed Loop Control of Chopper Fed Embedded DC Drives", IEEE Int. Conf., POWERCON, Singapore, 2004.
- [5] C. F. Lu, C. C. Liu, and C. J. Wu, "Dynamic Modeling of Battery Energy Storage System and Application to Power System Stability", IEE Proceedings Generation, Transmission & Distribution, Vol.142, No.4, pp.429-435, July, 1995.
- [6] K. Hussein, I.Muta, T. Hoshino and M. Oskada, "Maximum Photovoltaic Power Tracking; An Algorithm for Rapidly Changing Atmospheric Conditions", IEEE

Proceedings Generation, transmission and Distribution, Vol. 142, No 1, pp.59 -64, 1995.

[7] M. M. Saied and A. A. Hanafy, "A Contribution to the Simulation and Design Optimization of Photovoltaic Systems", IEEE Trans. Energy Conv., Vol. 6, pp. 401-406, Sep. 1991.

[8] D. H. Kim, A. Abraham, and J. H. Cho, "A Hybrid Genetic Algorithm and Bacterial Foraging Approach for Global Optimization", Information Sciences Vol. 177, No. 18, September 2007, pp. 3918-3937.

[9] K. M. Passino, "Biomimicry of Bacterial Foraging for Distributed Optimization and Control", IEEE. Control System Magazine, Vol. 22, No. 3, June 2002, pp. 52-67.

[10] S. Mishra, "A Hybrid Least Square Fuzzy Bacteria Foraging Strategy for Harmonic Estimation", IEEE Trans. Evolutionary Computer, Vol. 9, No.1, February 2005, pp. 61-73.

[11] D. B. Fogel, "Evolutionary Computation towards a New Philosophy of Machine Intelligence", IEEE, New York, 1995.

[12] E. S. Ali and S. M. Abd-Elazim, "Bacteria Foraging Optimization Algorithm Based Load Frequency Controller for Interconnected Power System", Int. J. of Electrical Power and Energy Systems, Vol. 33, No. 3, March 2011, pp. 633-638.

[13] N. S. Kumar, V. Sadasivam, and M. Muruganandam, "A LowCost Four quadrant Chopper Fed Embedded DC Drive Using Fuzzy Controller", Int.J. of Electric Power Components and Systems, Vol. 35, No. 8, August 2007, pp. 907 - 920.

[14] H.L.Tan, N.A. Rahim, and W.P. Hew, "A Dynamic Input Membership Scheme for a Fuzzy Logic DC Motor Controller", IEEE Int. Conf. on Fuzzy Systems, Vol. 1, 25-28 May 2003, pp. 426 - 429.

[15] P. Z. Lin, C. F. Hsu, T. T. Lee, "Type -2 Fuzzy Logic Controller design for Buck DC-DC Converters" Proceedings of the IEEE Int. Conf. on Fuzzy systems, 2005, pp. 365- 370.

[16] A. E. El-kholy, and A. M. Dabroom, "Adaptive Fuzzy Logic Controllers for DC Drives: A Survey of the State of the Art", J. of Electrical Systems 2-3, 2006, pp.116-145.

[17] J.Majed, C.Houda, J. Housseem, and B. B.Naceur, "Fuzzy Logic Parameter Estimation of an Electrical System", Systems, Signals and Devices, IEEE SSD 2008, 5th Int. Multi-Conf. on 20-22 July 2008, pp.1-6.

[18] B. K. Bose, "Modern Power Electronics and AC Drives", New Jersey: Prentice-Hall, 2002.

APPENDIX

The system data are as shown below:

a) DC series motor parameters are shown below.

DC motor parameters	Value
Motor rating	3.5HP
Motor rated voltage	240 V
Motor rated current	12 A
Inertia constant J_m	0.0027 Kg-m ²
Damping constant B	0.0019 N.m.Sec./rad
Armature resistance R_a	1.63 Ω
Armature inductance L_a	0.0204 H
Motor Speed	2000 rpm
Full load torque	19 N.m

b) Bacteria parameters: Number of bacteria =10; number of chemotactic steps =10; number of elimination and dispersal events = 2; number of reproduction steps = 4; probability of elimination and dispersal = 0.25; the values of $d_{attract}$ =0.01; the values of $\omega_{attract}$ =0.04; the values of $h_{repellent}$ =0.01; the values of $\omega_{repellent}$ =10.